



**CORICAMA**<sup>®</sup>  
since 1873

CATALOGO







## UNA STORIA CHE HA RADICI PROFONDE

### LE ORIGINI

CORICAMA è il frutto di una *storia plurisecolare*. Le nostre radici sono legate al luogo in cui viviamo, **Maniago**: una città capace di distinguersi con grande successo in tutto il panorama internazionale per le sue doti nell'*arte fabbrile*. **Fin dal 1380** nel nostro territorio battiferri e botteghe di fabbri hanno lavorato per produrre spade, alabarde e armature per la Repubblica Marinara di Venezia, oltre a strumenti per l'agricoltura e i mestieri dell'epoca. Qui, nel 1873 è nata la prima grande fabbrica di coltelli e strumenti da taglio di Maniago, la **CO.RI.CA.MA.: Coltellerie Riunite di Caslino e Maniago**

identificata da tutto il paese come "Lo Stabilimento". Nello stabilimento si sono formate molteplici generazioni di operai specializzati, poi diventati artigiani, uomini e donne che grazie alla loro professionalità, hanno prodotto e producono ancora oggi *coltelli, forbici, pinze, lame, strumenti chirurgici e altri utensili in acciaio per arti e mestieri*. Attualmente, il vecchio stabilimento CORICAMA, ristrutturato e di proprietà del Comune di Maniago, ospita il "Museo dell'arte fabbrile e delle coltellerie", una straordinaria esposizione dei prodotti tipici di Maniago che richiama turisti e visitatori da tutto il mondo. Per noi è un grande *orgoglio* poter legare le proprie *origini* ad una storia radicata nella *comunità a cui apparteniamo*.

**LE NUOVE STRATEGIE AZIENDALI**  
*CORICAMA ha da sempre fabbricato e fornito i propri strumenti per le più famose e rinomate aziende del settore dentale e chirurgico di tutto il mondo personalizzandoli con i loro nomi e marchi.*

Oggi, le nuove strategie aziendali, resesi necessarie per poter cogliere ulteriori opportunità di crescita e successo ci impongono di proporci e presentarci al mercato globale utilizzando anche il nostro logo e marchio CORICAMA

Lo Stabilimento CORICAMA (1907) >>>



Maglio CORICAMA (1949) >>>





COLTELLERIE RIUNITE  
DI CASLINO E MANIAGO

MADE IN ITALY



*Preziosi come gioielli,  
performanti come la tua  
mano: CORICAMA è garanzia  
di strumenti di alta qualità  
che si adattano perfettamente  
alla sensibilità del  
professionista e contribuiscono  
al benessere del paziente.*

*CORICAMA è costantemente  
accanto agli odontoiatri più  
esigenti e a coloro che cercano  
solo il meglio per il loro lavoro.*



## STILE ITALIANO E TECNOLOGIA AVANZATA

CORICAMA è **tradizione**  
e **stile italiano** dove  
**tecnologia e design** si fondono  
in una **combinazione**  
**raffinata** per dare vita  
ad una selezione di **strumenti**  
**efficienti, pratici ed eleganti.**

Il nostro **obiettivo** è ottenere  
standard sempre più elevati  
in termini di bellezza,  
**ergonomia e praticità**  
**degli strumenti:** la **ricerca**  
**estetica** di CORICAMA ben  
si lega agli **aspetti funzionali**  
e **strutturali**, che fanno del  
prodotto uno **strumento**  
**di lavoro di grande qualità.**

La **ricerca della perfezione**  
è per noi un progetto che non  
si arresta mai e la si riscontra  
nella cura dei dettagli,  
nell'eleganza e nell'accuratezza  
di ogni singolo prodotto.  
Ogni processo viene seguito  
ed eseguito in modo accurato:  
servono **grandi competenze**  
per produrre uno **strumento**  
**di eccellenza** che possa  
**meritare lo storico**  
**marchio CORICAMA.**





## VALORE ALL'INNOVAZIONE

*Innovazione* è per CORICAMA la ricerca e la selezione degli acciai *più idonei per la fabbricazione degli strumenti chirurgici* e delle *attrezzature più innovative* che *ottimizzano i processi produttivi* e mantengono alto di prestigio e competitivo il marchio CORICAMA.

Attraverso questi *processi continui di miglioramento* ed ai rigorosi controlli qualitativi, *estetici e funzionali* si vuole portare lo strumento CORICAMA sempre più vicino alla *perfezione*.

Ogni attività dell'azienda è spinta verso una intensa *specializzazione*, nella quale le *competenze delle persone* si integrano alle *nuove tecnologie*

ed al continuo confronto con i migliori ambienti scientifici di tutto il mondo. Per questo motivo CORICAMA stringe *collaborazioni con Università, il mondo scientifico e istituti di design* che stimolano la *ricerca* verso nuove linee di prodotti.

La nostra mission è ottenere – per mezzo di strumenti chirurgici sempre più performanti, affidabili e precisi – dei risultati operativi nettamente migliori rispetto a quelli del passato e dare così anche il nostro contributo al progresso per migliorare la salute ed il benessere delle persone.





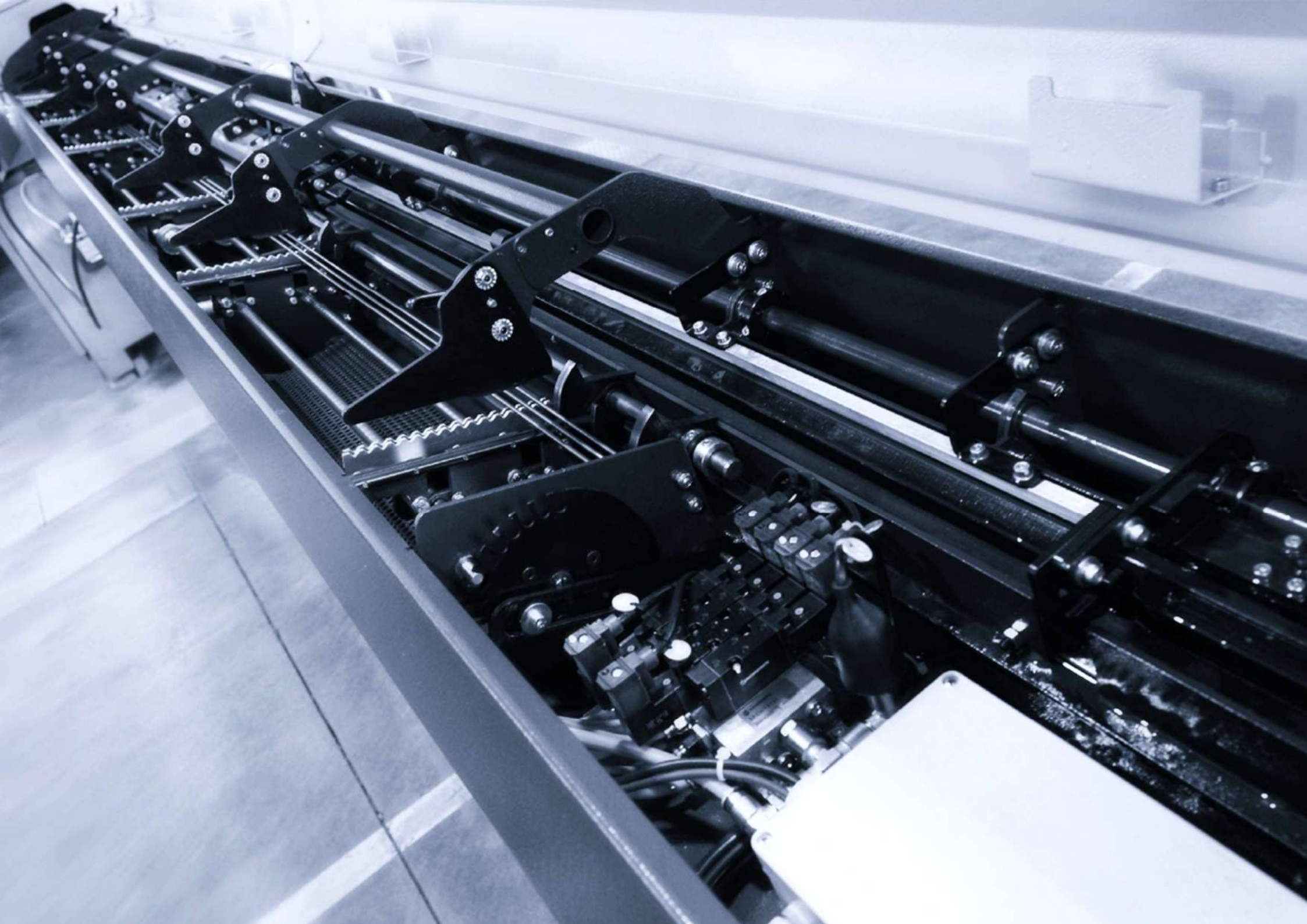

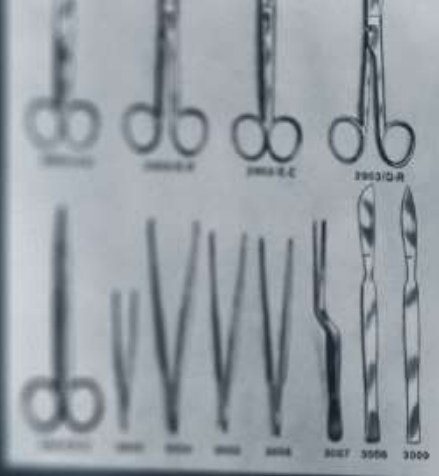

## CI PRENDIAMO CURA DELLE TUE ESIGENZE

Con orgoglio, sin dal 1873, la CORICAMA è sul mercato e si prende cura delle esigenze dei clienti proponendo soluzioni e risposte pronte, precise e utili. Garantisce inoltre servizi curati e in base alle necessità del cliente; favorisce rapporti di collaborazione basati sul lungo termine e sulla reciproca stima e fiducia. Tutto questo nell'interesse di favorire e coniugare armoniosamente gli interessi ed i benefici fra produttore e cliente.



## AFFIDABILITA'

La nostra principale attenzione è la performance dello strumento CORICAMA nelle mani del professionista! È quello il momento in cui si mette alla prova *l'affidabilità dello strumento* ed il lungo percorso che lo ha portato dallo stadio di progettazione al suo utilizzo sul campo. Esprimiamo con orgoglio di appartenere ad una *azienda leader sul mercato dal 1873 i cui prodotti sono fin da allora sinonimo di garanzia e affidabilità.*

Chi conosce l'azienda e gli strumenti CORICAMA, e alcuni nostri pregiatissimi clienti ci conoscono da allora, sa che può contare su una azienda seria, professionale, concreta e disponibile.



# TAVOLA DEI CONTENUTI



DIAGNOSTICA

SPECCHIETTI  
MANICI  
PINZETTE  
SPECILLI  
SPECCHIETTI  
FOTOGRAFICI



PARODONTOLOGIA

SONDE  
PINZETTE  
CURETTES  
SCALERS  
OLIO E PIETRE  
PER AFFILATURA



CONSERVATIVA

STRUMENTI PER  
DIGA DENTALE  
STRUMENTI PER  
COMPOSITO  
STRUMENTI PER  
SMALTO  
ESCAVATORI  
STRUMENTI PER  
CORONE



ENDODONZIA

PINZE PER  
ENDODONZIA  
ESPLORATORI  
PLUGGERS  
SPREADERS  
CONTENITORI PER  
ENDODONZIA



IMPLANTOLOGIA

OSTEOTOMI  
STRUMENTI PER  
IL RIALZO DEL  
SENO MASCELLARE  
MARTELLI  
PINZETTE  
CALIBRI

# TAVOLA DEI CONTENUTI



## CHIRURGIA

MANICI E LAME  
PER BISTURI

PORTA AGHI

FORBICI

DIVARICATORI

CANNULE PER  
ASPIRAZIONE

PINZETTE

SCOLLAPERIOSTEI

CUCCHIAI ALVEOLARI

SIRINGHE

## ESTRAZIONE

PINZE ESTRAZIONE  
FORMA INGLESE

PINZE ESTRAZIONE  
FORMA AMERICANA

PINZE ESTRAZIONE  
PEDIATRICHE

PINZETTE  
ESTRAZIONE

LEVE PER  
RADICI

## ORTODONZIA

TRONCHESI

PINZE

STRUMENTI PER  
BANDE

STRUMENTI PER  
BRACKETS

FORBICI  
PER FILI

## PROTESICA

STRUMENTI PER  
MODELLARE

PINZETTE

PINZE

ARTICOLATORI

PORTA IMPRONTE

CALIBRI

## ACCESSORI

VASSOI PER  
STERILIZZAZIONE

VASSOI  
UNIVERSALI

CONTENITORI  
E TAZZE

DISTRIBUTORI  
PER COTONE  
E BICCHIERI

# TAVOLA DEI CONTENUTI



---

KITs & SETs

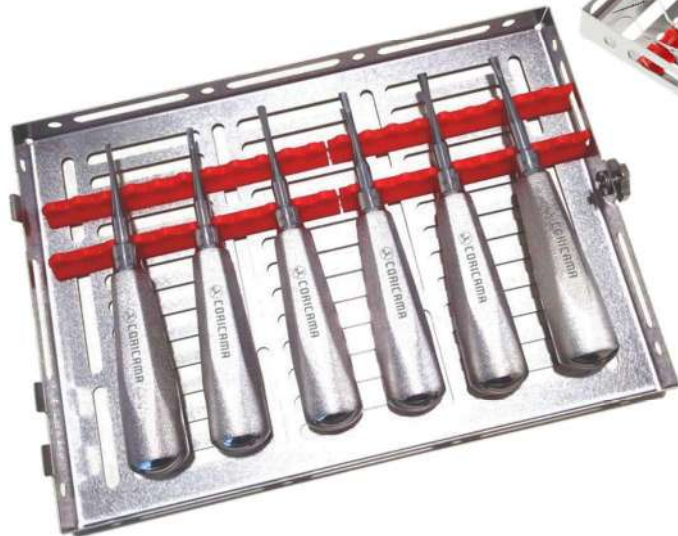

CONTENUTO  
PERSONALIZZABILE  
SU RICHIESTA DEL CLIENTE



**CORICAMA**<sup>®</sup>  
since 1873

DIAGNOSTICA

# SPECCHIETTI



**Stelo Semplice - EU**  
(Filettatura Europea-Metrica)

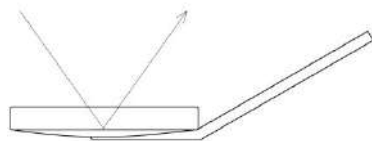

Lo strato riflettente è nella parte inferiore del vetro e l'immagine viene riflessa da sotto la superficie del vetro.

**110125**

N.4  
PIANI  
Stelo Semplice EU  
Confezione da  
12 pz

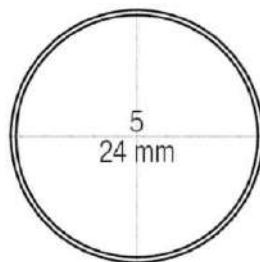

**110130**

N.5  
PIANI  
Stelo Semplice EU  
Confezione da 12 pz



**133502**

MANICO SPECCHIETTO MOD. LISCIO  $\phi$  8mm+  
SPECCHIETTI N.5 PIANI (1 pz)

**110220**

N.4  
RODIO  
Stelo Semplice EU  
Confezione da  
12 pz

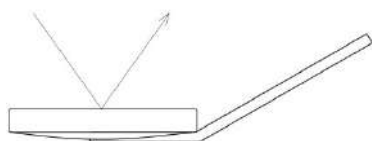

**Front Surface**

L'immagine viene riflessa dallo strato riflettente superficiale in Rodio.

**110225**

N.5  
RODIO  
Stelo Semplice EU  
Confezione da  
12 pz



Superficie riflettente leggermente curva per una visualizzazione più dettagliata.

**110620**

N.4  
INGRANDIENTE  
Stelo Semplice EU  
Confezione da  
12 pz

**110625**

N.5  
INGRANDIENTE  
Stelo Semplice EU  
Confezione da  
12 pz



**110810**  
MICRO -  
SPECCHIETTO  
PRISMATICO



**110820**  
MICRO -  
SPECCHIETTO  
QUADRATO



**110830**  
MICRO -  
SPECCHIETTO  
TONDO



# MANICI

**Cone-Socket AM** (Filettatura Americana-Imperiale)

**113710**      **113810**      **113850**  
 ANATOMICO      OTTAGONALE      ESAGONALE

Cone-Socket AM Specchietti disponibili su richiesta



MICRO - SPECCHIETTI  
 e  
 MICRO - LAME



**Stelo Semplice - EU** (Filettatura Europea-Metrica)

**113700**  
 ANATOMICO

**113800**  
 OTTAGONALE

**113840**  
 ESAGONALE

**113860**  
 ESAGONALE  
 Millimetrato /  
 Graduato (mm)

**113880**  
 OTTAGONALE

**113500**  
 LISCIO  
 ø 8mm

**112030**  
 MANICO MOD. LISCIO  
 112010  
 Manico Zigrinato

# PINZETTE



**161560**  
FLAGG  
mm150



**161565**  
COLLEGE  
mm150



**161770**  
MERIAM  
mm160



**162560**  
FLAGG  
mm150



**162565**  
COLLEGE  
mm150



**162585**  
COLLEGE  
mm150  
CON FERMO



**162770**  
MERIAM  
mm160



**162780**  
MERIAM  
mm160  
Diamantata

# SPECILLI Manico Singolo



**170410**  
N.2



**170415**  
N.23



**170425**  
N.3A



**170440**  
N.11



**170450**  
N.12



**170455**  
N.8A



**170460**  
N.9



**170465**  
N.10



**170470**  
N.16



**170475**  
N.6



**170490**  
N.17



SOLID  
Ø 6mm

# SPECILLI Manico Doppio



 SOLID  
 Ø 6mm



**178420**  
 N.23  
 N.17  
 Wilken



**178430**  
 N.23  
 N.17A



**178440**  
 N.23  
 N.6

3-6-9-12



12-9-6-3

Per misurare la profondità orizzontale e verticale della tasca dei denti multi-radicali nelle aree di forzazione.

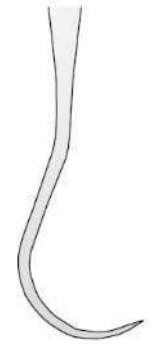

**178490**  
 2N  
 NABERS

**178485**  
 2N  
 NABERS

Marcatura Laser:  
 mm 3-6-9-12

# SPECCHIETTI FOTOGRAFICI

Per immagini intra-orali necessarie alla pianificazione del trattamento di restauro, alla valutazione dell'arcata dentale e delle superfici oclusali dei denti. Uno specchio posizionato correttamente abbastanza in profondità nella bocca del paziente, cattura tutta la panoramica fino alla parte distale dei secondi molari.

Eliminare o ridurre l'appannamento riscaldando lo specchio (mettendolo sotto l'acqua calda) appena prima dell'inserimento o chiedere semplicemente all'assistente di soffiare delicatamente sullo specchio.

E' anche utile chiedere al paziente di trattenere il respiro quando lo specchio è inserito per evitare ulteriore appannamento.

Utilizzare divaricatori appropriati per manipolare le labbra del paziente e per creare uno spazio sufficiente per poter inserire lo specchio.

(Vedi pagine 107 e 522-531).



**142020**  
OCCLUSALE ADULTO  
3x73x105mm  
(0.12x2.87x4.13in)



**142040**  
OCCLUSALE PEDIATRICO  
3x57x75mm  
(0.12x2.24x2.95in)



**142060**  
LINGUALE  
3x41x157mm  
(0.12x1.61x6.18in)



**142080**  
BUCCALE  
3x53x157mm  
(0.12x2.09x6.18in)

# DIVARICATORI FOTOGRAFICI

Bordi smussati e arrotondati per evitare di infierire sulla gengiva e minimizzare il disagio per il paziente.

Per consentire la massima visualizzazione di tutti i denti e le creste alveolari, retraino e tirare le guance e le labbra del paziente lateralmente e allontanarle (leggermente in avanti) dai denti e dalla gengiva.

La forma speciale dei retrattori e degli espansori fotografici permettono che le guance e le labbra si ripieghino verso l'esterno.

Bagnare i retrattori poco prima dell'inserimento facilita il processo di posizionamento con un disagio minimo per il paziente.



**561910**  
DIVARICATORE ESPANSORE  
GUANCE/LABBRA



**561920**  
DIVARICATORE ESPANSORE  
GUANCE/LABBRA PEDIATRICO



**561930**  
DIVARICATORE  
FORMA - V



**561940**  
DIVARICATORE  
FORMA - C



**CORICAMA**<sup>®</sup>  
since 1873

PARODONTOLOGIA

# SONDE – Manico Singolo (Marcatura Laser)

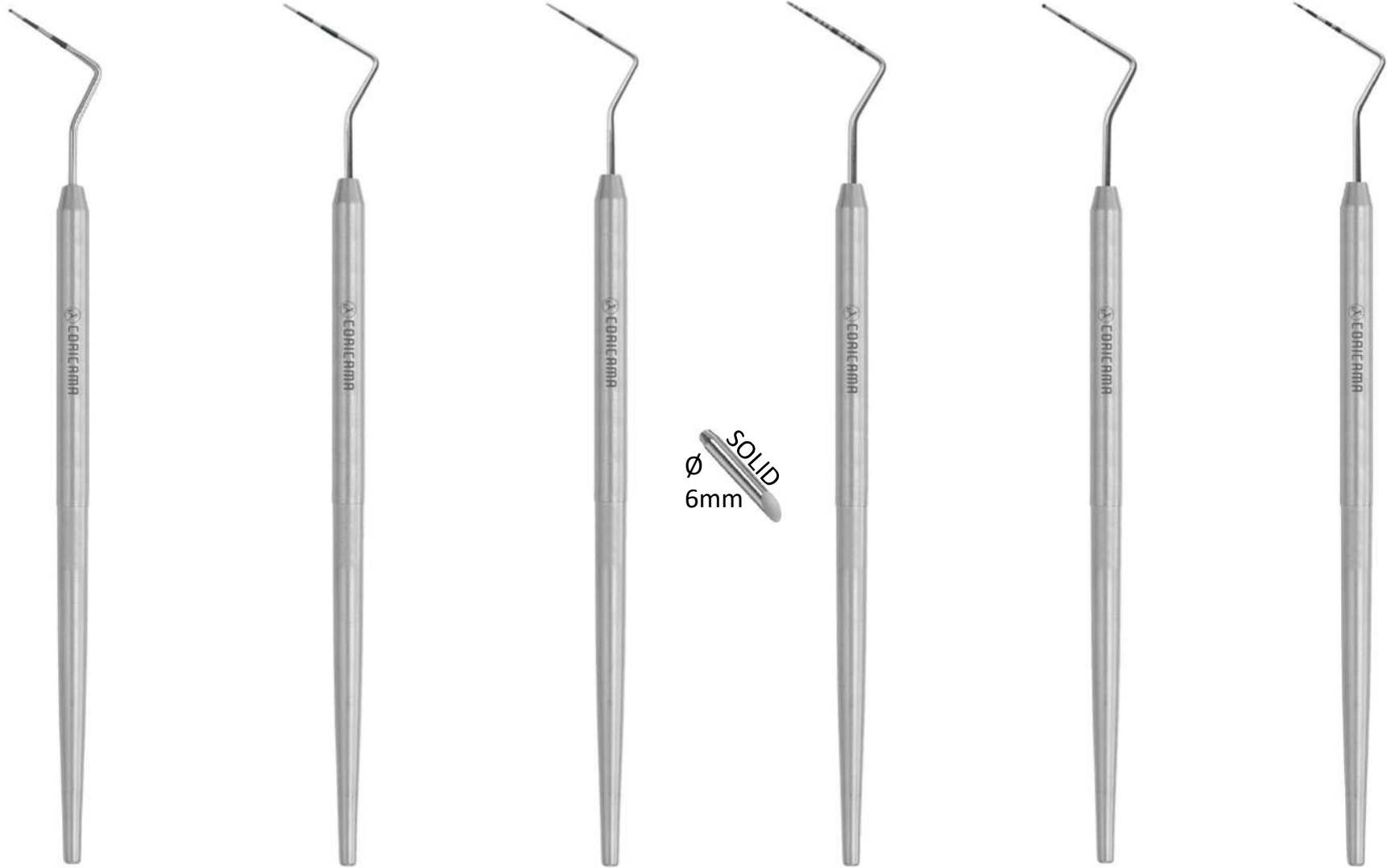

**212410**

CP12S

O.M.S.

mm3-6-9-12

**212420**

CP11

mm3-6-8-11

**212430**

CP12

mm3-6-9-12

**212440**

CP15 / UNC

University of  
North Carolina

mm1-2-3-4-5-6-7-8-  
9-10-11-12-13-14-15

**212450**

WHO

mm3,5-5,5-  
8,5-11,5

**212460**

CP10

Goldman-Fox  
Color Code  
mm1-2-3-5-  
6-7-8-9-10

SOLID  
Ø 6mm



# SONDE – Manico Singolo

# PINZETTE Segna Tasche



**212465**  
WILLIAMS  
Arrotondata  
mm1-2-3-  
5-7-8-9-10



**212470**  
MERRIT A  
Arrotondata  
mm1-2-3-5-  
6-7-8-9-10

SOLID  
Ø  
6mm



**212475**  
MERRIT E  
Arrotondata  
mm1-2-3-  
5-7-8-9-10



**212480**  
GOLDMAN-FOX  
Piatta  
mm1-2-3-5-  
6-7-8-9-10



**214710**  
PINZETTA  
CRANE-KAPLAN  
SINISTRA  
mm1-2-3-5-6-7-8-9



**214715**  
PINZETTA  
CRANE-KAPLAN  
DESTRA  
mm1-2-3-5-6-7-8-9

# SONDE – Manico Doppio

## Marcatura Scanalata

## Marcatura Laser



**214410**  
WILLIAMS  
mm1-2-3-  
5-7-8-9-10

**214435**  
GOLDMAN-FOX  
mm1-2-3-5  
-7-8-9-10

**214450**  
WILLIAMS  
mm1-2-3-5  
-7-8-9-10

**214460**  
GOLDMAN-FOX  
WILLIAMS  
mm1-2-3-5-7-8-9-10

**214480**  
CP11/23  
mm3-6-8-11

**214485**  
CP12/23  
mm3-6-9-12

# CURETTES GRACEY

## Arcata Superiore

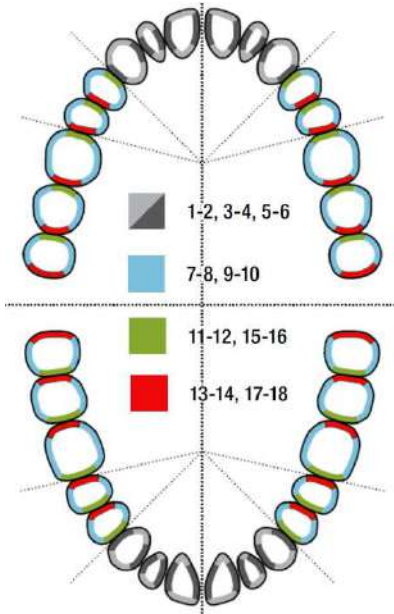

## Arcata Inferiore

- Denti Anteriori:**  
 1/2 - Incisivi e Canini  
 3/4 - Incisivi e Canini  
 5/6 - Anteriori e Premolari
- Superfici Buccali e Linguali dei denti posteriori:**  
 7/8 - Premolari e Molari  
 9/10 - Premolari e Molari
- Superfici Mesiali dei denti posteriori:**  
 11/12 - Premolari e Molari  
 15/16 - Premolari e Molari
- Superfici Distali dei denti posteriori:**  
 13/14 - Molari  
 17/18 - Molari



### TIPO STANDARD

- Specifiche per area: progettate per adattarsi alla superficie del dente da trattare.
- Affilate solo su un lato.
- Lama/Spigolo Tagliente angolato di 70 gradi rispetto allo stelo.
- Sezione semi-circolare e punte arrotondate per una pulizia subgingivale meno traumatica.

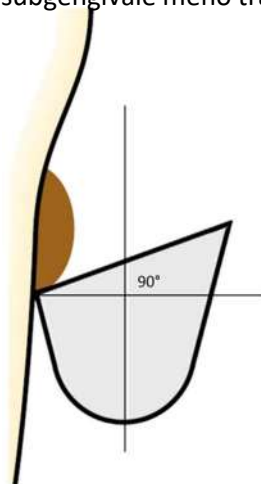

### TIPO "RIGID"

- Stelo più grosso e meno flessibile rispetto alle "Gracey Standard".
- Indicate per operazioni che solitamente richiedono l'utilizzo di Scalers.



### TIPO "LONG"

- Stelo più lungo di 3mm rispetto alle "Gracey Standard" per intervenire più in profondità nelle tasche parodontali.



### TIPO "SHORT"

- Stelo più lungo di 3mm rispetto alle "Gracey Standard" e con la parte terminale più corta per intervenire più in profondità nelle tasche parodontali strette.

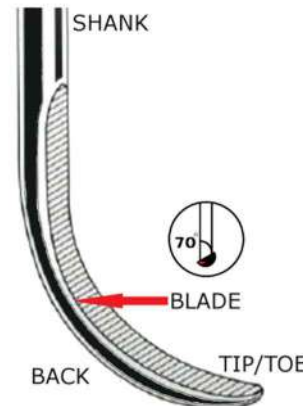

- Per la rimozione del tartaro sub-gingivale e la pulizia radicolare.
- Manico Liscio Arrotondato  $\varnothing$  8mm finitura lucidata per una pulizia più facile e confortevole.
- Vedi differenze tra Curettes GRACEY e UNIVERSAL rispetto agli SCALERS (pagina 210).



# CURETTES GRACEY STANDARD

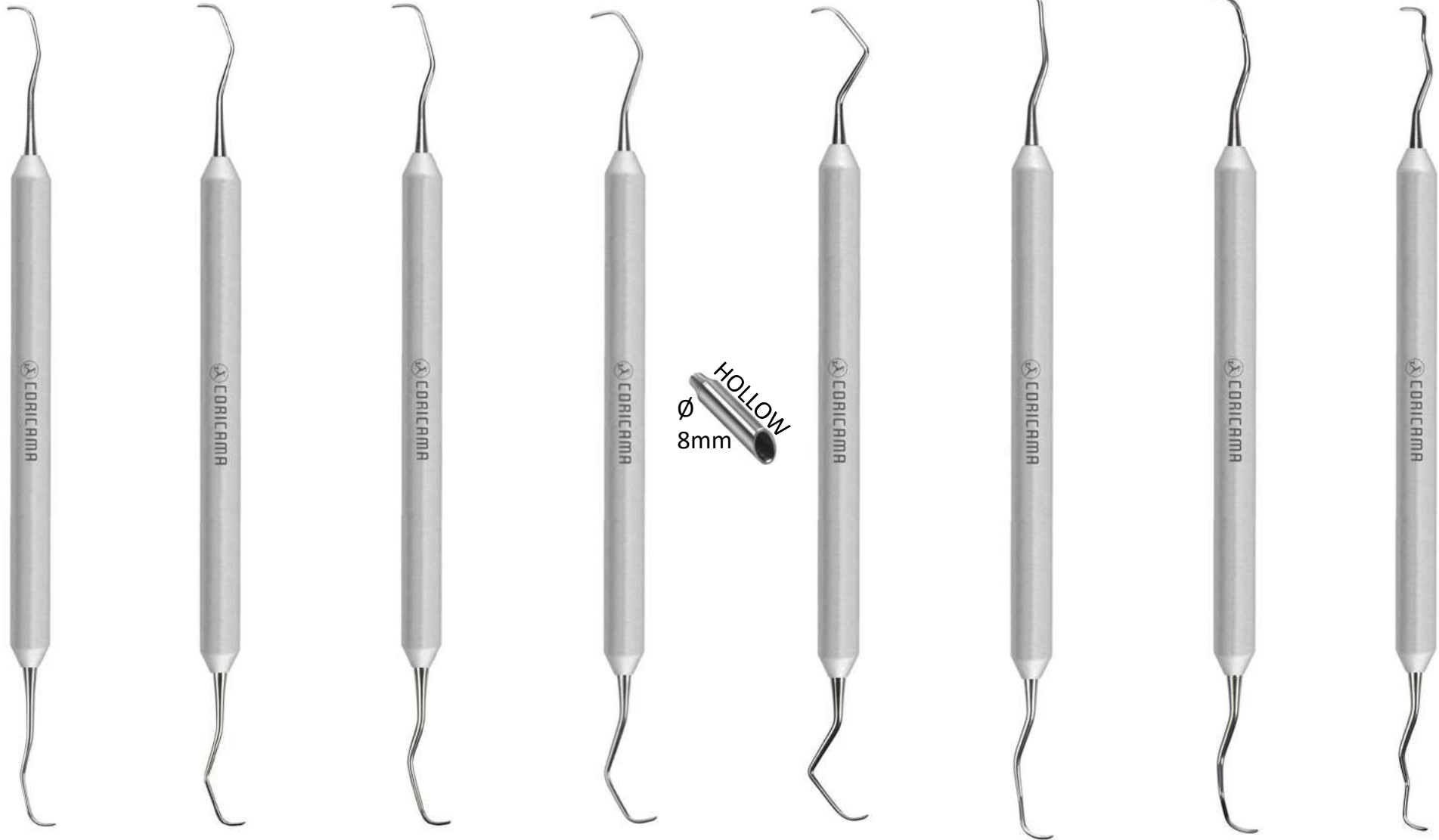

**215510**  
GRACEY  
1-2

**215520**  
GRACEY  
3-4

**215530**  
GRACEY  
5-6

**215540**  
GRACEY  
7-8

**215550**  
GRACEY  
9-10

**215560**  
GRACEY  
11-12

**215570**  
GRACEY  
13-14

**215580**  
GRACEY  
15-16

# CURETTES GRACEY STANDARD – ALLUMINIO



**215813**  
GRACEY  
1-2



**215823**  
GRACEY  
3-4



**215833**  
GRACEY  
5-6



**215843**  
GRACEY  
7-8

SOLID  
Ø 8mm



**215853**  
GRACEY  
9-10



**215863**  
GRACEY  
11-12



**215873**  
GRACEY  
13-14



**215883**  
GRACEY  
15-16

# CURETTES GRACEY TIPO "RIGID"



**217510**  
GRACEY  
1-2



**217520**  
GRACEY  
3-4



**217530**  
GRACEY  
5-6



**217540**  
GRACEY  
7-8



**217550**  
GRACEY  
9-10



**217560**  
GRACEY  
11-12



**217570**  
GRACEY  
13-14

# CURETTES GRACEY TIPO "LONG"



**218510**  
GRACEY  
1-2



**218520**  
GRACEY  
3-4



**218530**  
GRACEY  
5-6



**218540**  
GRACEY  
7-8



**218550**  
GRACEY  
9-10



**218560**  
GRACEY  
11-12



**218570**  
GRACEY  
13-14

# CURETTES GRACEY TIPO "SHORT"



**219510**  
GRACEY  
1-2



**219520**  
GRACEY  
3-4



**219530**  
GRACEY  
5-6



**219540**  
GRACEY  
7-8



**219550**  
GRACEY  
9-10



**219560**  
GRACEY  
11-12



**219570**  
GRACEY  
13-14



# CURETTES UNIVERSALI

## CURETTES GRACEY

- Per la rimozione del tartaro sub-gengivale e la pulizia radicolare.
- Specifiche per area: progettate per adattarsi alla superficie del dente da trattare.
- Affilate solo su un lato.
- Lama/Spigolo Tagliente angolato di 70 gradi rispetto allo stelo.
- Sezione semi-circolare e punte arrotondate per una pulizia subgengivale meno traumatica.

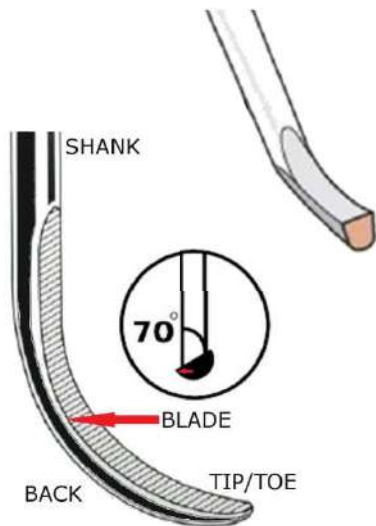

## CURETTES UNIVERSALI

- Per la rimozione del tartaro sub-gengivale e la pulizia radicolare
- Progettate per adattarsi a tutte superficie dentali da trattare.
- Affilate su entrambi lati.
- Lama/Spigolo Tagliente perpendicolare (90°) gradi rispetto allo stelo.
- Sezione semi-circolare e punte arrotondate per una pulizia subgengivale meno traumatica.

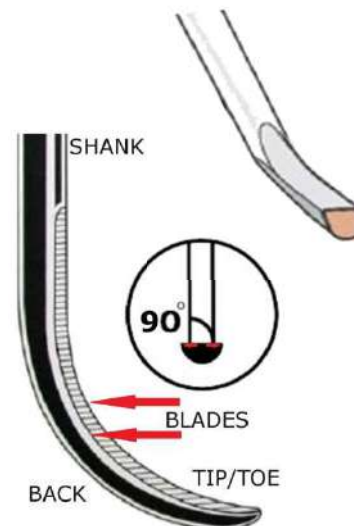

## SCALERS

- Per la rimozione del tartaro sopra-gengivale
- Progettate per adattarsi a tutte superficie dentali da trattare.
- Affilate su entrambi lati.
- Lama/Spigolo Tagliente perpendicolare (90°) gradi rispetto allo stelo.
- Sezione triangolare e punte affilate per una più efficace pulizia sopra-gengivale.

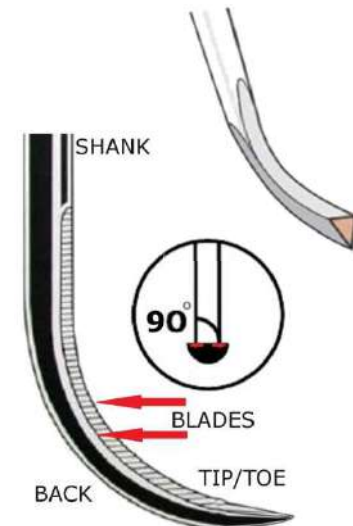

(Vedi differenze tra GRACEY TIPO STANDARD, RIGID, LONG e SHORT a pagina 204)

# CURETTES UNIVERSALI

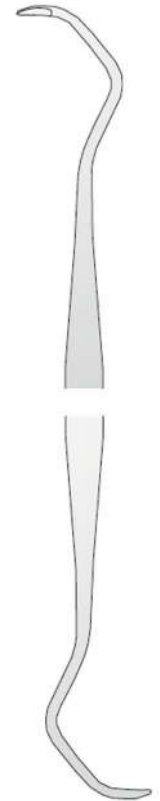
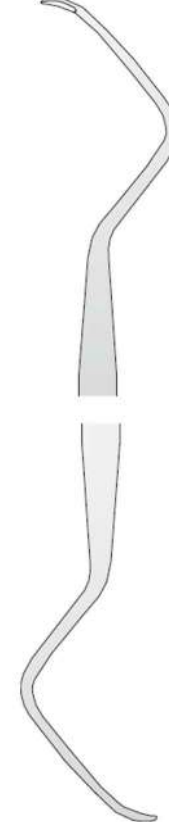
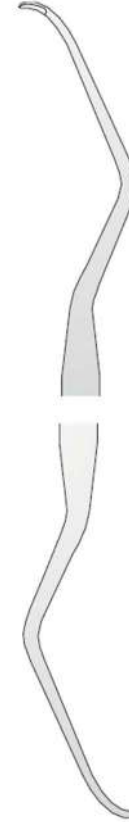
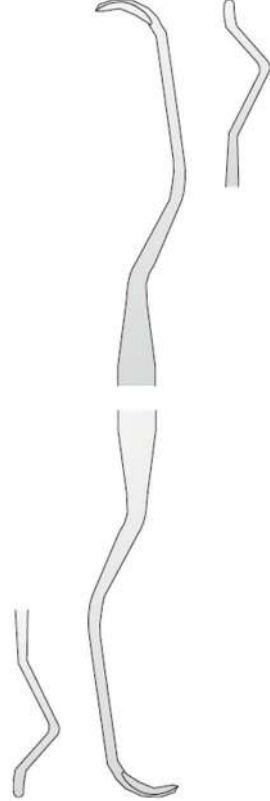
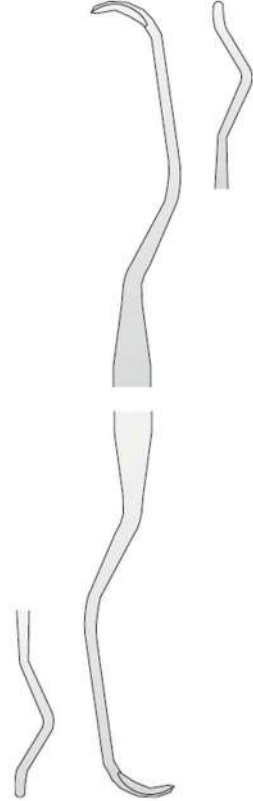
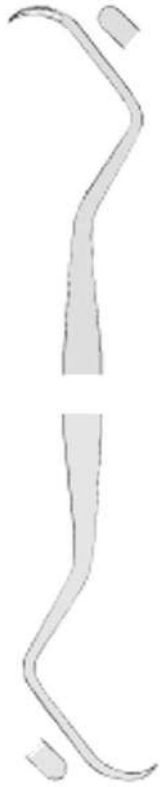
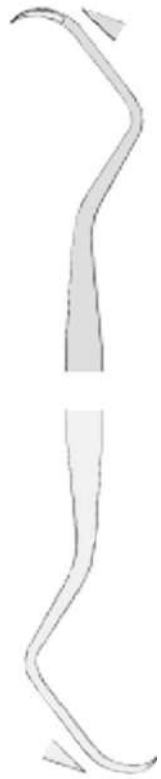

**222530**  
TIPO SVIZZERO  
UNIVERSALI

**222540**  
TIPO SVIZZERO

**223510**  
LANGER  
1/2

**223520**  
LANGER  
3/4

**223530**  
LANGER  
5/6

**223540**  
COLUMBIA  
2R/2L

**223550**  
COLUMBIA  
4R/4L

**223560**  
COLUMBIA  
13/14



# CURETTES UNIVERSALI

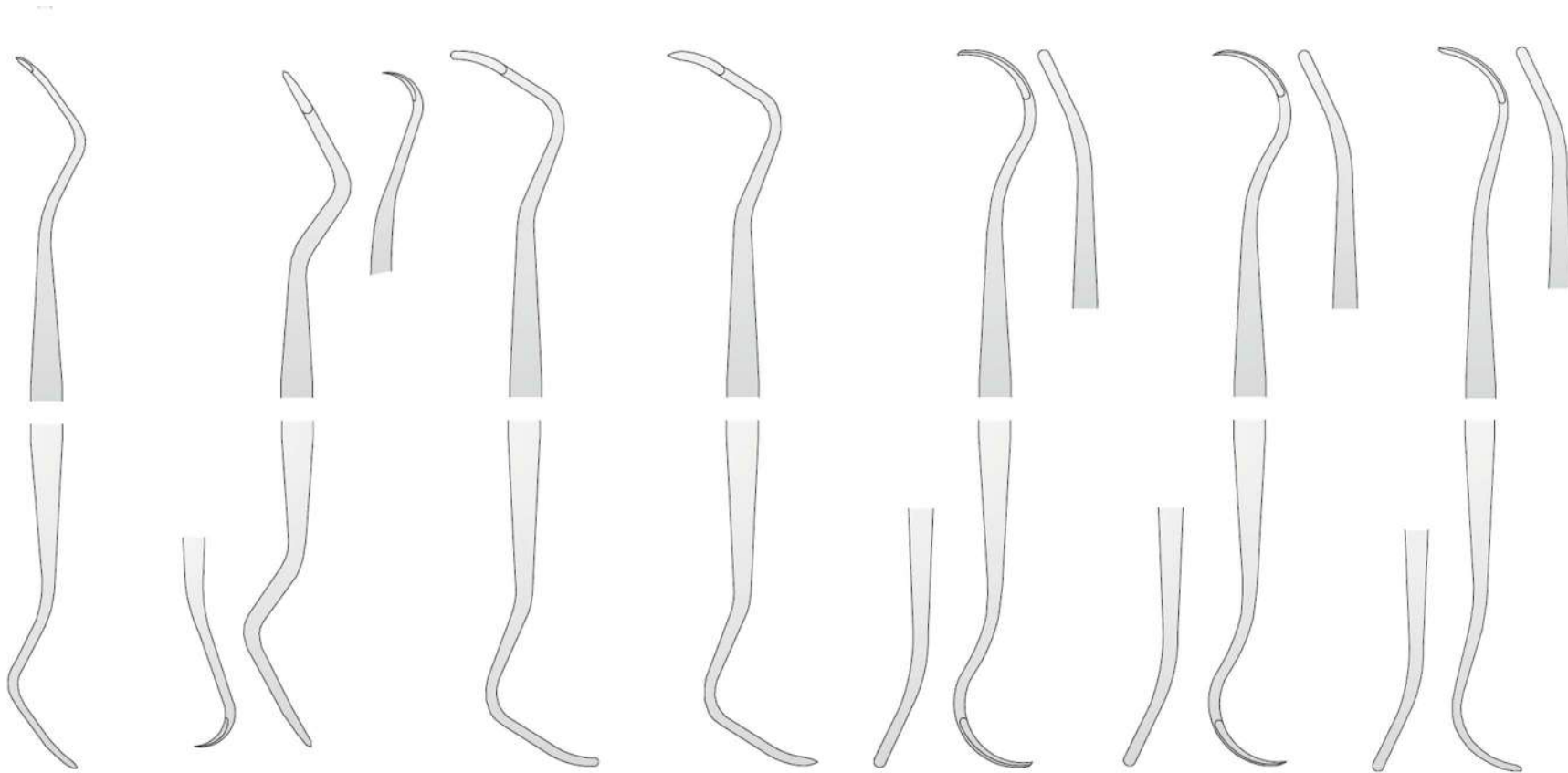

**224510**  
McCALL  
11/12

**224520**  
McCALL  
11A/12A

**224530**  
McCALL  
13/14

**224540**  
McCALL  
13S/14S

**224550**  
McCALL  
17/18

**224560**  
McCALL  
17S/18S

**224570**  
McCALL  
19/20



# CURETTES UNIVERSALI

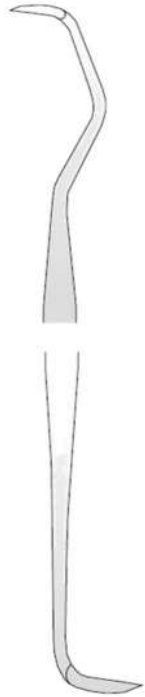

**225510**  
GOLDMAN-FOX  
N.1

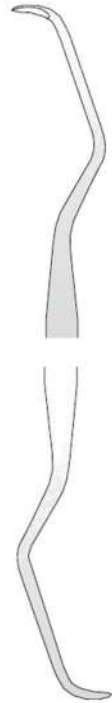

**225520**  
GOLDMAN-FOX  
N.2

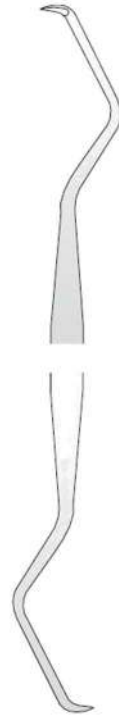

**225530**  
GOLDMAN-FOX  
N.3

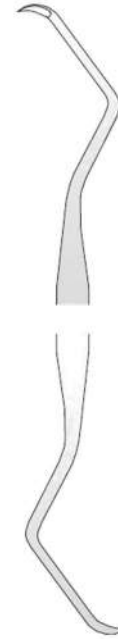

**225540**  
GOLDMAN-FOX  
N.4



**225550**  
GOLDMAN-FOX  
N.5



# SCALERS

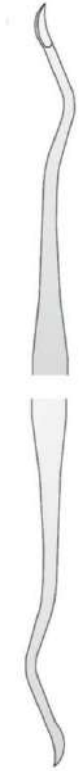

**234510**  
204 SD

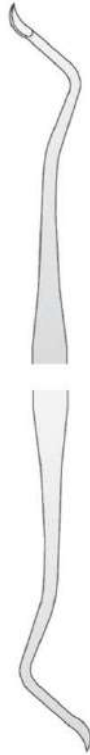

**234520**  
204S

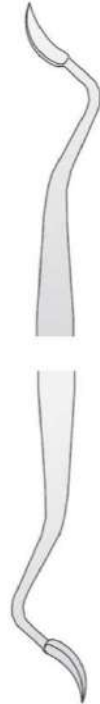

**234540**  
TAYLOR  
2/3



**234550**  
CI  
2/3



**234560**  
CRANE-KAPLAN  
CK6



HOLLOW  
Ø 8mm

# SCALERS



**235430**  
DARBY-PERRY  
1R

**235435**  
DARBY-PERRY  
1L

**235440**  
DARBY-PERRY  
2R

**235445**  
DARBY-PERRY  
2L

**235460**  
WILLIGER

**235470**  
TOWNER  
U15

**235880**  
MITCHELL

**235890**  
CUMINE

----- PARODONTOLOGIA 215

**CORICAMA**  
SINCE 1981

Ø **SOLID**  
6mm

# SCALERS

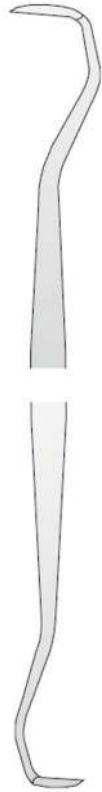

**236540**  
JAQUETTE  
30-33

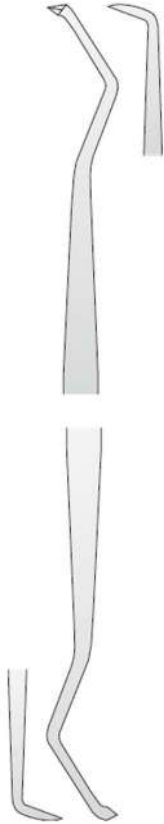

**236550**  
JAQUETTE  
31-32

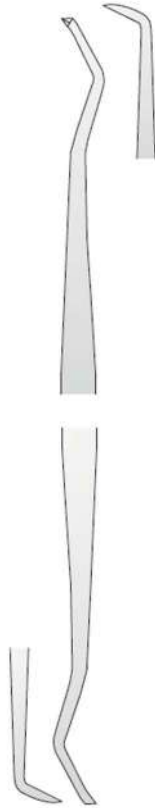

**236555**  
JAQUETTE  
34-35

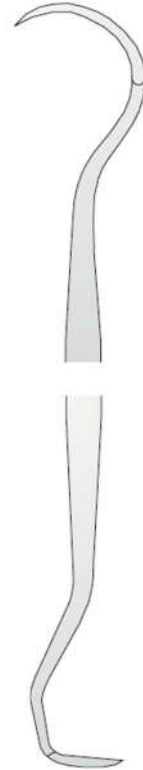

**236570**  
TOWNER-JAQUETTE  
U15-30

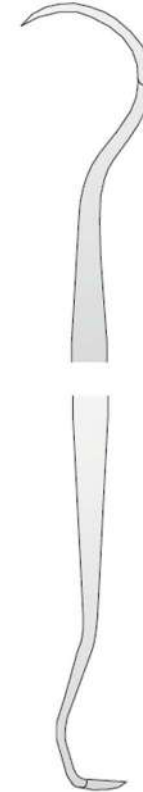

**236575**  
TOWNER-JAQUETTE  
U15-33

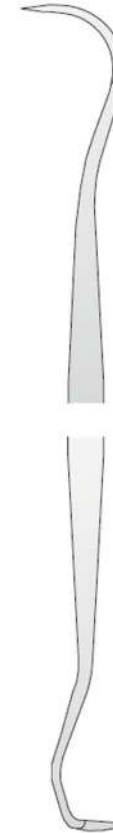

**236580**  
HYGENIST-TOWNER  
H5/33



HOLLOW  
Ø 8mm



# SCALPELLI

----- PARODONTOLOGIA 217



**251510**  
FEDI  
N.1



**251520**  
FEDI  
N.2



**251530**  
FEDI  
N.3



**251540**  
TG

HOLLOW  
Ø 8mm



**251550**  
TG-0



**251560**  
OCHSENBEIN  
N3



**251570**  
OCHSENBEIN  
N4



**251580**  
RHODES  
N.36/37



SOLID  
Ø 6mm

**251490**  
ZERFING  
Ø 6mm



# BISTURI per GENGIVECTOMIA

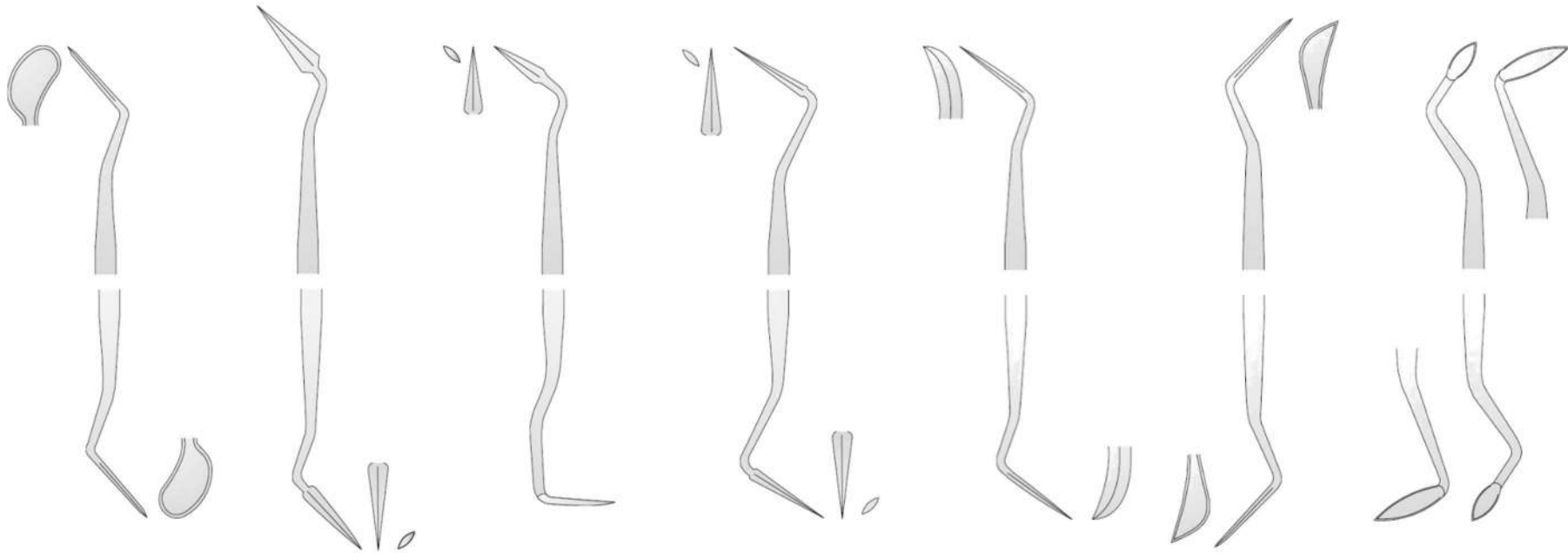

**262510**

GOLDMAN-FOX  
N.7

**262520**

GOLDMAN-FOX  
N.8

**262530**

GOLDMAN-FOX  
N.9

**262540**

GOLDMAN-FOX  
N.11

**264520**

CRANE-KAPLAN  
CK3

**264550**

KIRKLAND  
N.15/N.16

**264580**

ORBAN  
N.1/N.2



HOLLOW  
Ø 8mm

# LIME



**272550**  
BUCK  
11/12



**272560**  
SCHLUGER  
9/10



**272570**  
SUGARMAN  
3S/4S



**272580**  
SUGARMAN  
1S/2S

# AFFILATURA

**291110**  
ARKANSAS  
EXTRA FINE



**291120**  
INDIA  
MEDIA



**291140**  
NATURALE  
FINE



**291150**  
SILICIO  
FINE



**291180**  
OLIO ml 50





**CORICAMA**<sup>®</sup>  
since 1873

CONSERVATIVA

# UNCINI per DIGA DENTALE

## Anteriori



**315320**

N.210

Lame di ancoraggio  
piccola e grande

Denti: 6-7-8-9-  
10-11-22-23-  
24-25-26-27



**315330**

N.212

Lame di ancoraggio  
piatte per cavità  
labiali

Denti: 6-7-8-9-  
10-11-22-23-  
24-25-26-27



**315350**

N.00

Lame di ancoraggio  
piccole e arco alto

Denti: 6-7-8-9-  
10-11-22-23-  
24-25-26-27

## Premolari



**315410**

N.27

Lame di ancoraggio  
arrotondate

Denti: 4-5-12-  
13-20-21-28-29



**315420**

N.29

Lame di ancoraggio  
piatte e arrotondate

Denti: 4-5-12-  
13-20-21-28-29



**315440**

N.208

Lame di ancoraggio  
piatte per premolari

Denti: 4-5-12-  
13-20-21-28-29



**315470**

N. 1

Uso generico su  
premolari superiori

Denti: 4-5-12-13



**315490**

N. 2A

Lame di ancoraggio  
grandi e piatte per  
premolari inferiori

Denti: 20-21-  
28-29

## Arcata Superiore

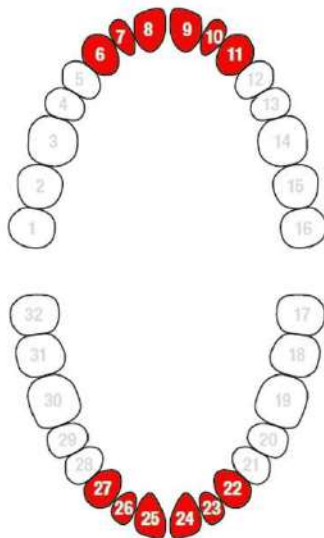

## Arcata Inferiore

## Arcata Superiore

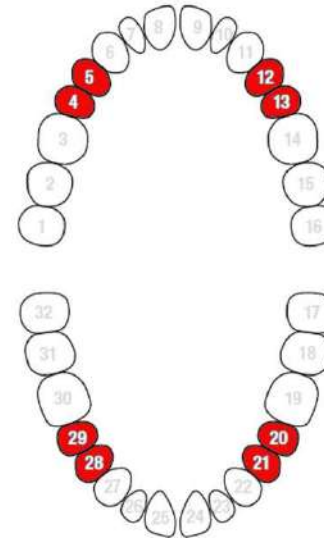

## Arcata Inferiore

# UNCINI per DIGA DENTALE

## Molari



**315570**

N.W8A

USO GENERICO

Denti: 1-2-3-14-  
15-16-17-18-19-  
30-31-32

## Molari inferiori



**315610**

N. 3

Lame di ancoraggio  
piatte per piccoli  
molari inferiori

Denti: 17-18-19-  
30-31-32



**315620**

N. 7

Lame di ancoraggio  
piatte per uso generico  
su molari inferiori

Denti: 17-18-19-  
30-31-32



**315650**

N.13A

Lame dentellate per  
molari sinistri  
(e alcuni superiori  
destri)

Denti: (1-2-3)-  
17-18-19



**315660**

N.12A

Lame dentellate per  
molari destri  
(e alcuni superiori  
sinistri)

Denti: (14-15-16)-  
30-31-32

## Molari superiori



**315730**

N. 5

Lame di ancoraggio  
grandi

Denti: 1-2-3-  
14-15-16



**315750**

N. 8

Usi generici su  
Molari superiori

Denti: 1-2-3-  
14-15-16

## Arcata Superiore

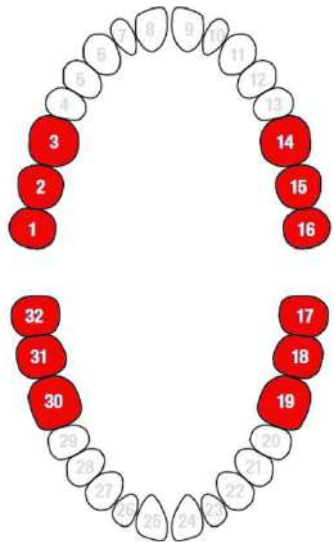

## Arcata Inferiore

## Arcata Superiore

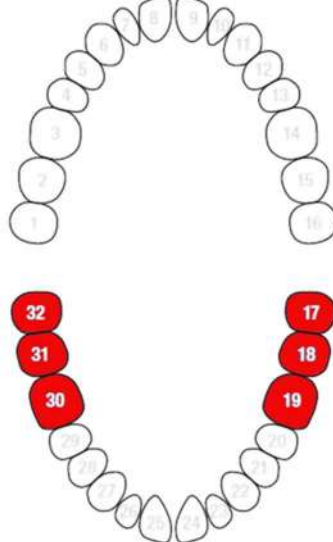

## Arcata Inferiore

## Arcata Superiore

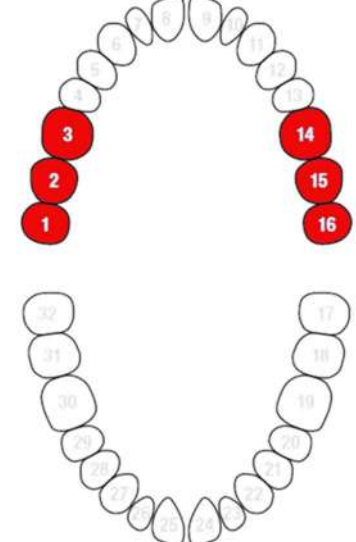

## Arcata Inferiore

# Strumenti per DIGA DENTALE



**315230**  
PINZA  
FORADIGA  
AINSWORTH



**315240**  
PINZA  
FORADIGA  
IVORY

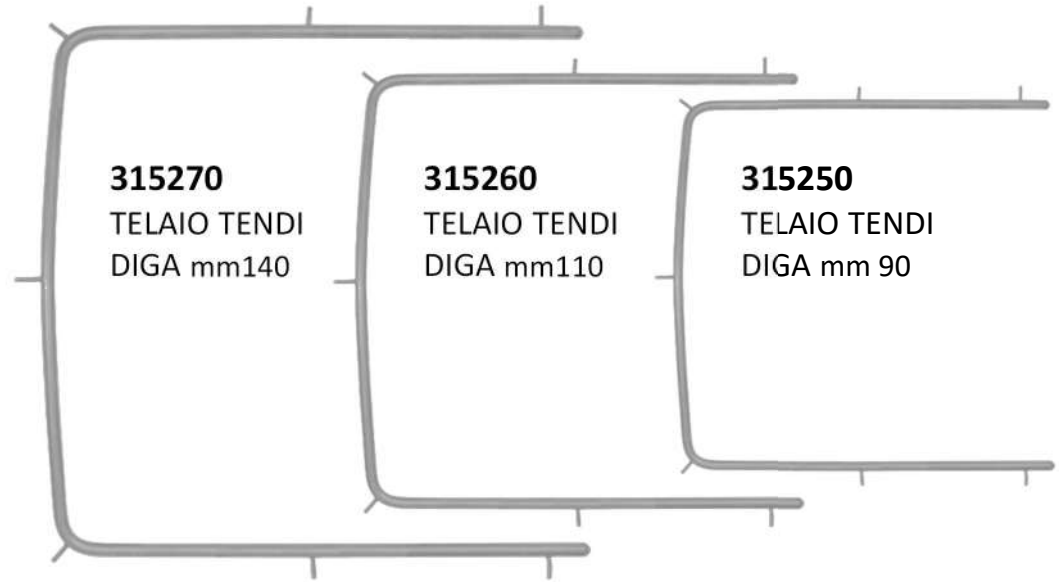

**315270**  
TELAIO TENDI  
DIGA mm140

**315260**  
TELAIO TENDI  
DIGA mm110

**315250**  
TELAIO TENDI  
DIGA mm 90



**315840**  
PINZA PER UNCINI



**315830**  
PINZA PER UNCINI  
IVORY



**315860**  
PINZA PER UNCINI  
WASHINGTON



**315870**  
PINZA PER UNCINI  
BREWER



**315880**  
PINZA PER UNCINI  
WHITE

# Strumenti per OTTURAZIONE

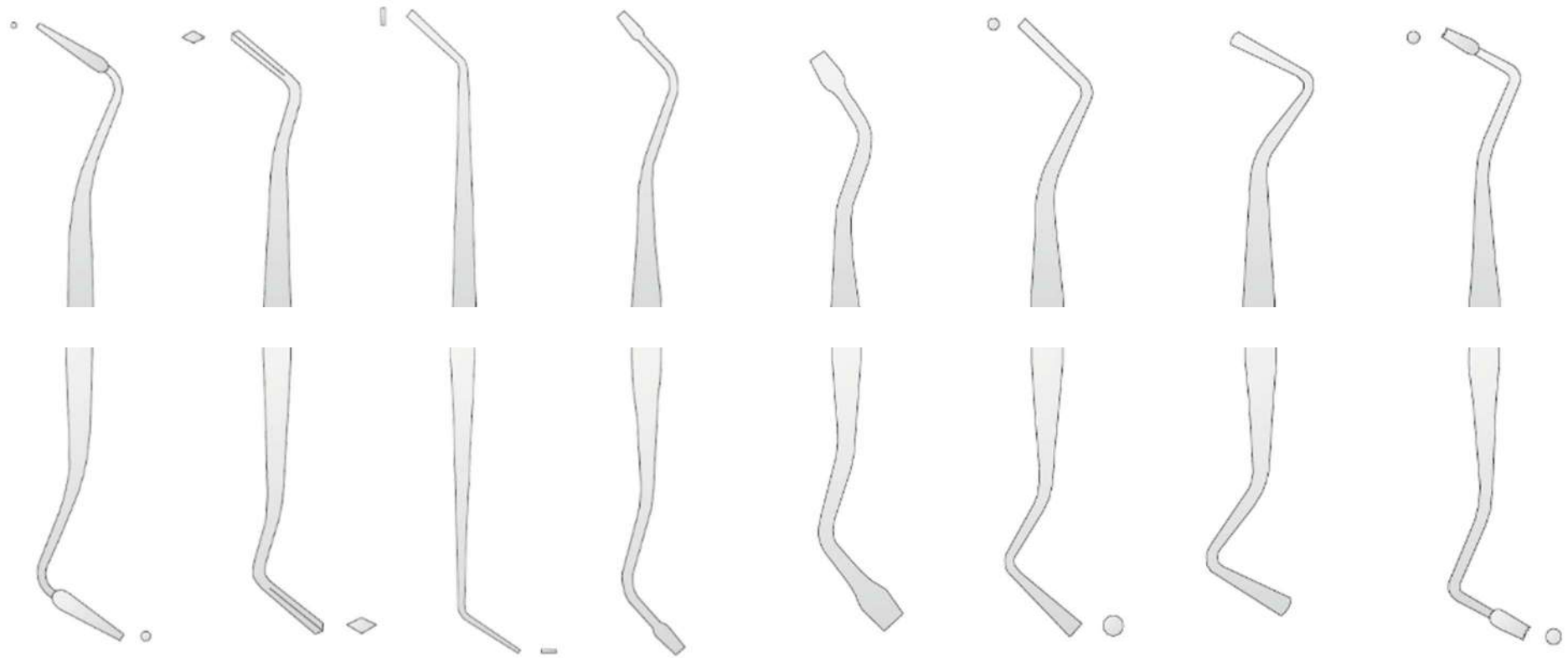

**321430**  
MARKLEY  
N.2  
mm0,6/1,1

**321460**  
MARKLEY  
N.4  
mm1,5/2,8

**321470**  
MARKLEY  
N.5  
mm1,2/1,2

**322420**  
HOLLENBACK  
H1  
mm1,0/1,7

**322440**  
HOLLENBACK  
H2  
mm2,0/2,7

**323460**  
TANNER  
2T  
mm1,0/1,3

**323480**  
TANNER  
3T  
mm1,6/2,0

**323490**  
MARQUETTE  
0/1 ZIGRINATO  
mm1,0/1,4



# Strumenti per OTTURAZIONE



**324420**  
M1  
mm1,2/1,5

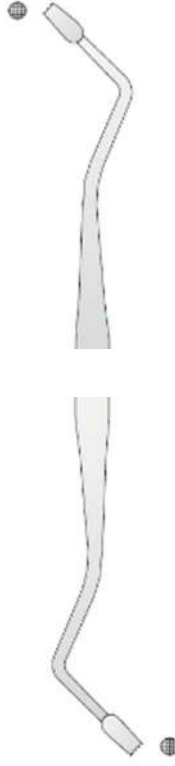

**324430**  
M1Z  
mm1,2/1,5  
ZIGRINATO

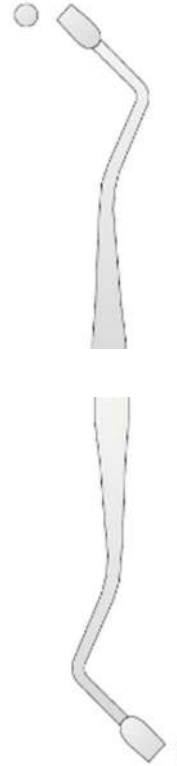

**324440**  
M2  
mm1,9/2,2

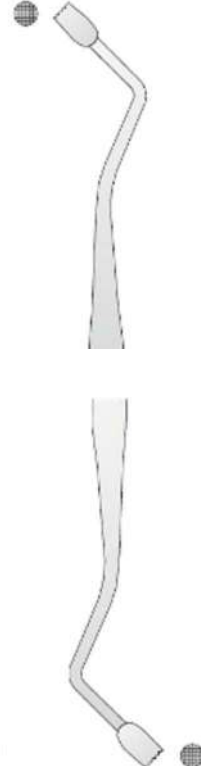

**324450**  
M2Z  
mm1,9/2,2  
ZIGRINATO

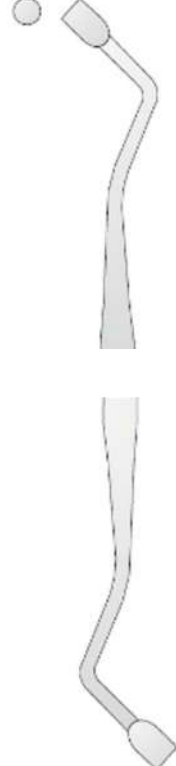

**324460**  
M3  
mm2,4/2,7

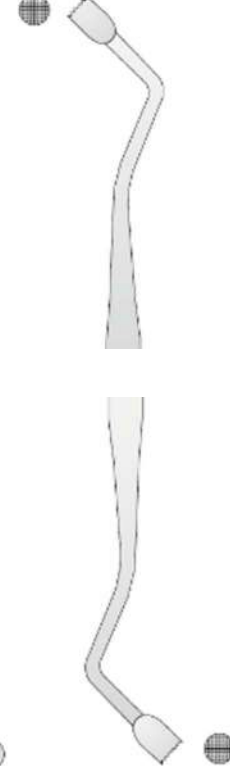

**324470**  
M3Z  
mm2,4/2,7  
ZIGRINATO

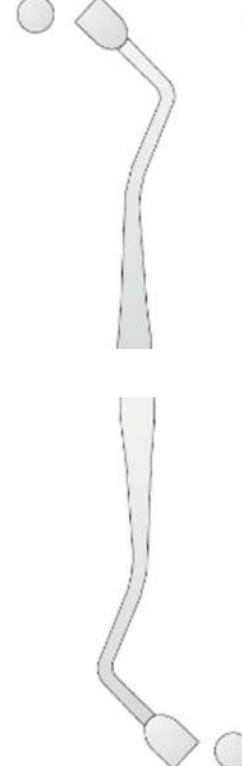

**324480**  
M4  
mm2,8/3,1

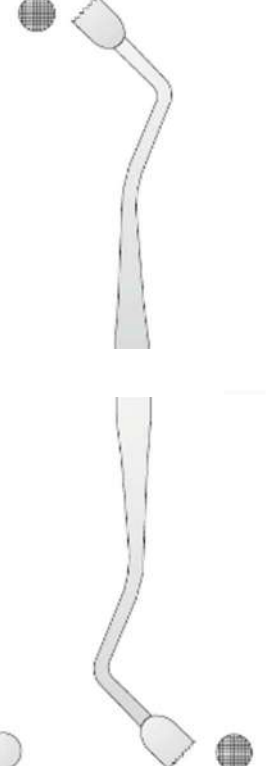

**324490**  
M4Z  
mm2,8/3,1  
ZIGRINATO

 **SOLID**  
6mm



# Strumenti per OTTURAZIONE

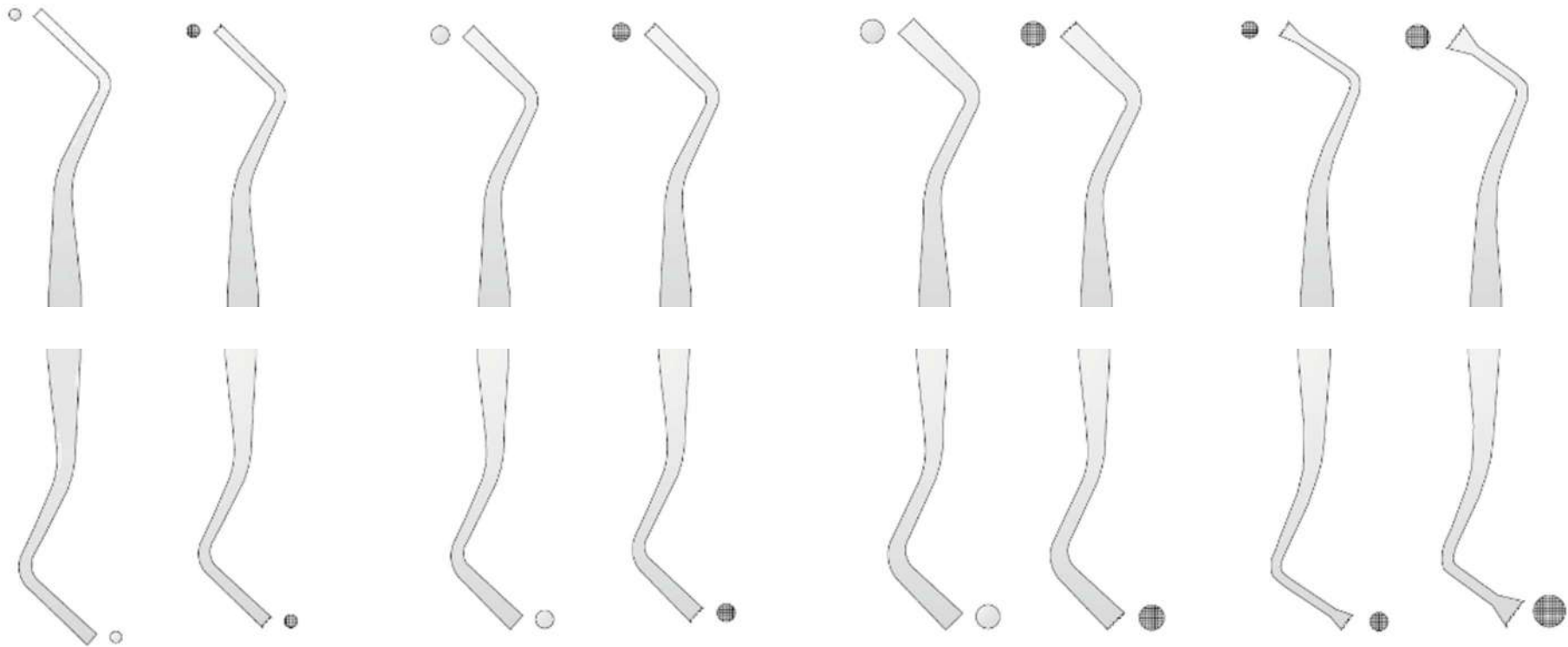

**325410**  
MT1  
mm1,0/1,4

**325420**  
MT1Z  
mm1,0/1,4  
ZIGRINATO

**325440**  
MT2  
mm1,85/2,0

**325450**  
MT2Z  
mm1,85/2,0  
ZIGRINATO

**325460**  
MT3  
mm2,2/2,4

**325470**  
MT3Z  
mm2,2/2,4  
ZIGRINATO

**325480**  
WARD 1  
mm1,8/2,0  
ZIGRINATO

**325490**  
WARD 2  
mm2,5/2,8  
ZIGRINATO



# Strumenti per OTTURAZIONE

307  
----- CONSERVATIVA



CORICAMA

∅  
6mm



**326410**  
OT1  
mm1,0/1,1



**326420**  
OT2  
mm1,35/1,75



**326430**  
OT3  
mm1,9/2,15



**326440**  
OT4  
mm1,8/3,0



**326460**  
BALL 26/27S  
mm1,3/2,0



**326470**  
BALL 18  
mm1,6/2,4



**326480**  
BALL 27/29  
mm1,8



**326490**  
BALL 28/29



**326495**  
2-29

# Strumenti per OTTURAZIONE



**327420**  
WESTCOTT N.21  
mm2,2/2,5

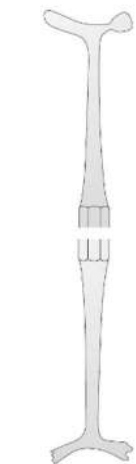

**329860**  
BENNET



**327440**  
ROMEROWSKI



**329870**  
WHITE  
N.32



**327450**  
LADMORE N.2  
mm1,3/1,9



**329880**  
WHITE  
N.33



**327460**  
LADMORE N.3  
mm1,3/1,9



**329890**  
WHITE  
N.29



**327470**  
mm1,0/1,2



**327480**  
mm1,4/1,6



**327490**  
mm1,8/2,0

Utilizzato per la preparazione del materiale plastico ed il riempimento delle cavità dentali.

Le punte hanno forme e design diversi per adattarsi alle dimensioni e alla forma delle cavità dentali.

Manico singolo o doppio, con spatole piatte, punta sferica, cilindrica, ovoidale o romboidale.



**SOLID**  
Ø 6mm

# Strumenti per COMPOSITO



RIVESTIMENTO IN TITANIO

<b>331812</b>	<b>331822</b>	<b>331832</b>	<b>331837</b>	<b>331842</b>	<b>331852</b>	<b>331857</b>	<b>331862</b>	<b>331867</b>	<b>331877</b>	<b>331882</b>
N.1	N.2	N.3	N.4	N.5	N.6	N.7	N.8	N.9	N.11	N.12
mm1,9/2,1	mm2,1/2,4	mm2,2/1,3	mm2,2/1,3	mm1,9/1,0	mm1,7/1,0	mm1,2/1,3	mm2,0/2,5	mm2,0/2,5	mm1,2/1,7	

## 331802

SET STRUMENTI  
PER COMPOSITO  
Rivestimento in  
Titanio

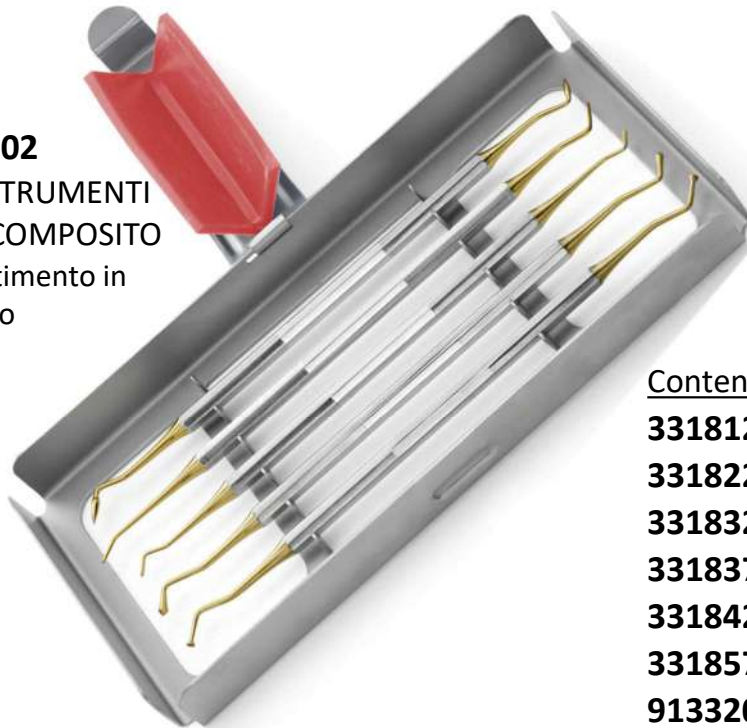

Contenuto:

- 331812** N.1
- 331822** N.2
- 331832** N.3
- 331837** N.4
- 331842** N.5
- 331857** N.7
- 913320** Vassoio piccolo

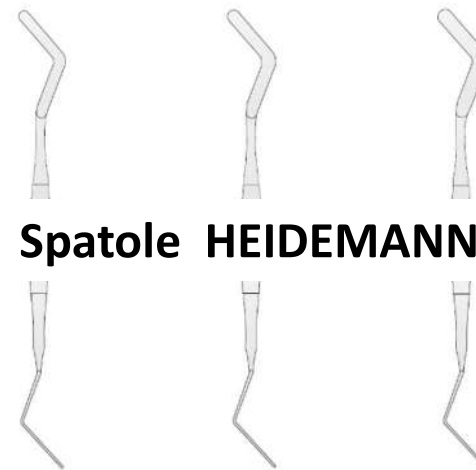

Spatole HEIDEMANN

<b>336420</b>	<b>336440</b>	<b>336460</b>
N.1	N.2	N.3
mm2,0/2,0	mm2,5/2,5	mm3,0/3,0



6mm

# Strumenti per COMPOSITO

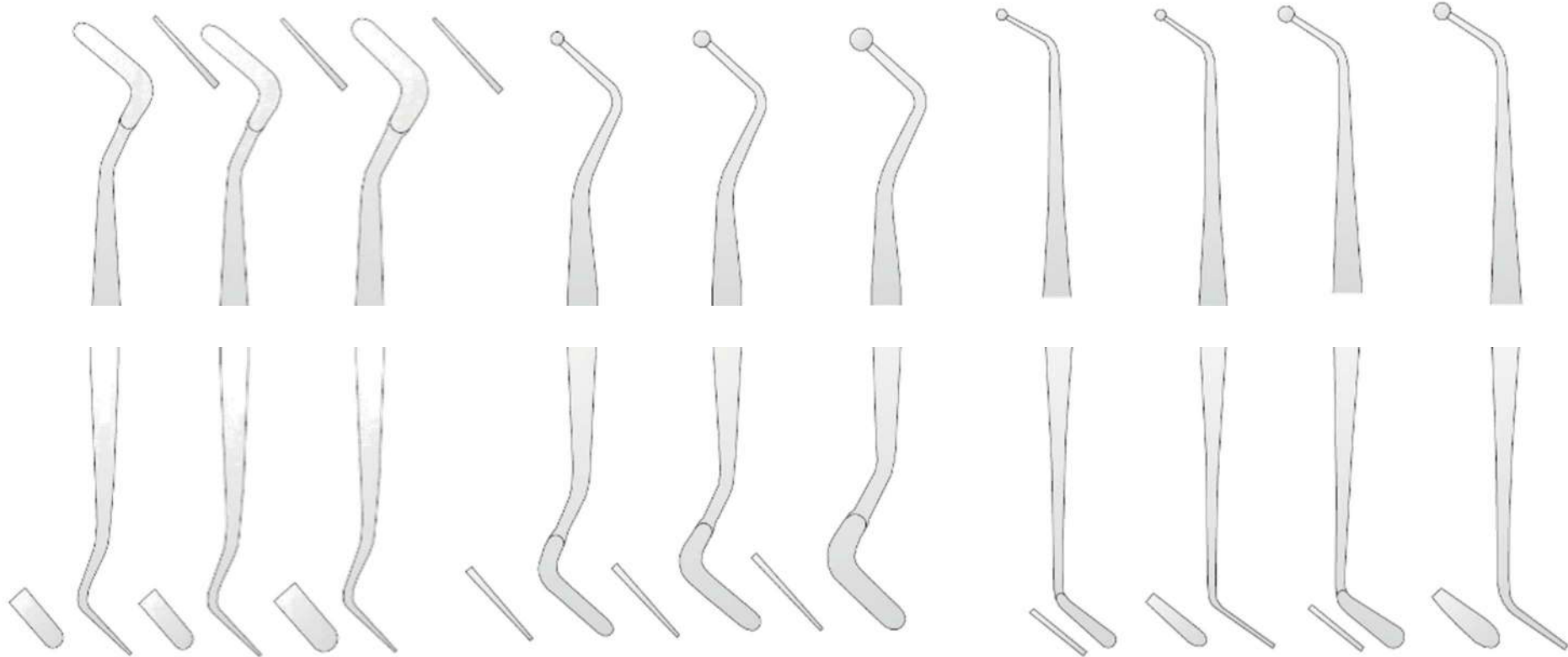

**332420**

SS1

mm2,0/2,0

**332450**

SS2

mm2,5/2,5

**332480**

SS3

mm2,9/2,9

**333420**

BS1

mm1,0/1,7

**333440**

BS2

mm1,45/2,0

**333460**

BS3

mm2,0/2,5

**334420**

BP3

mm1,2/1,6

**334430**

BP1

mm1,2/1,8

**334440**

BP4

mm1,7/1,8

**334450**

BP2

mm1,7/2,4

Ø  
6mm



310

CONSERVATIVA

CORICAMA

# Strumenti per COMPOSITO

311 CONSERVATIVA

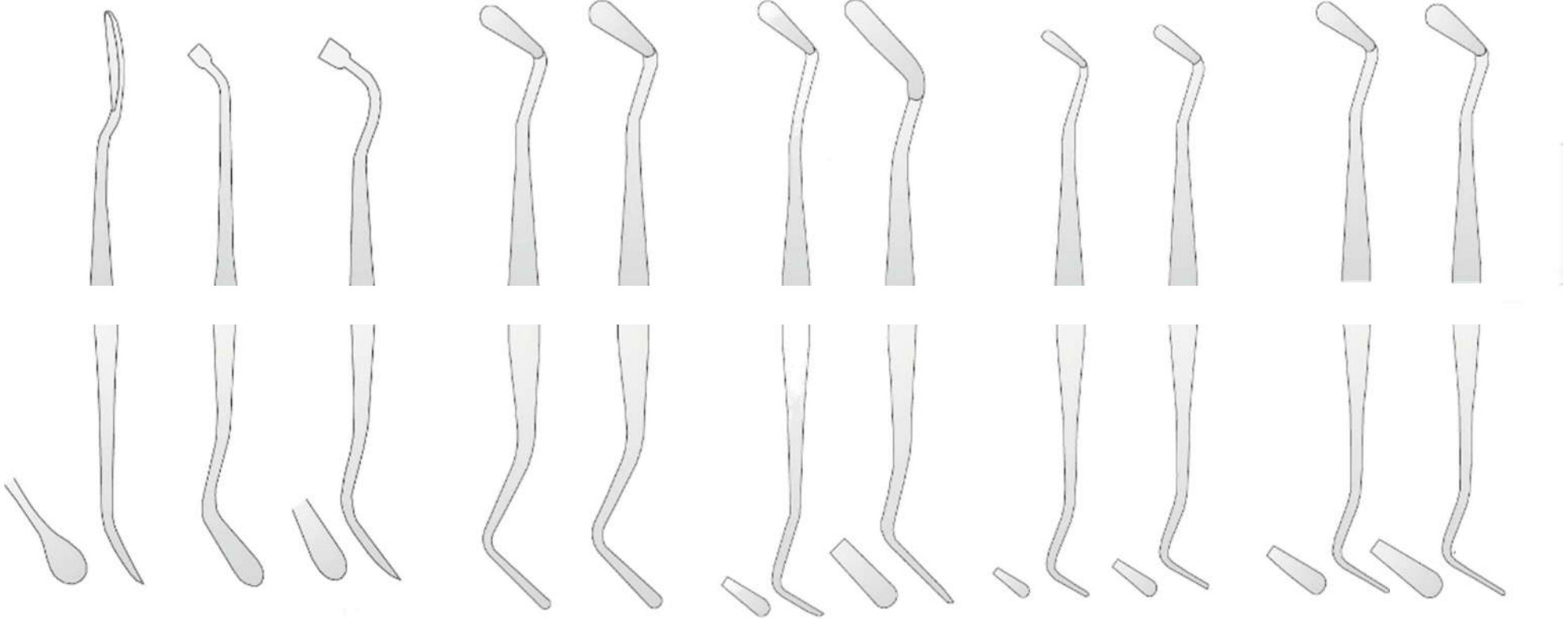

<b>334470</b>	<b>334480</b>	<b>334490</b>	<b>335410</b>	<b>335420</b>	<b>335430</b>	<b>335440</b>	<b>335460</b>	<b>335470</b>	<b>335480</b>	<b>335490</b>
WOODSON	WOODSON	WOODSON	PF1A	PF1	N.179	N.11	N.10	N.11	N.12	N.13
N.1	N.2	N.3								

			mm1,7/0,9	mm1,9/1,15	mm2,3/2,3	mm2,5/2,5	mm1,4/1,4	mm1,6/1,5	mm2,2/2,2	mm2,6/2,6
--	--	--	-----------	------------	-----------	-----------	-----------	-----------	-----------	-----------

CORICAMA

Ø 6mm  
SOLID

# Strumenti per SMALTO (Taglia Margini)

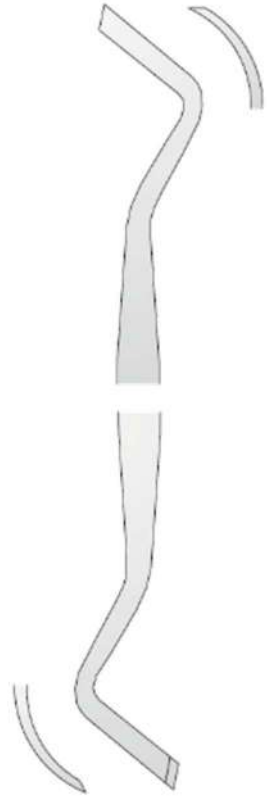

**337430**  
Black  
N.26  
Distale

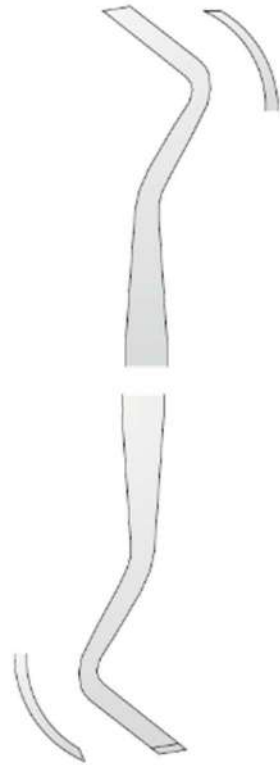

**337435**  
Black  
N.27  
Mesiale

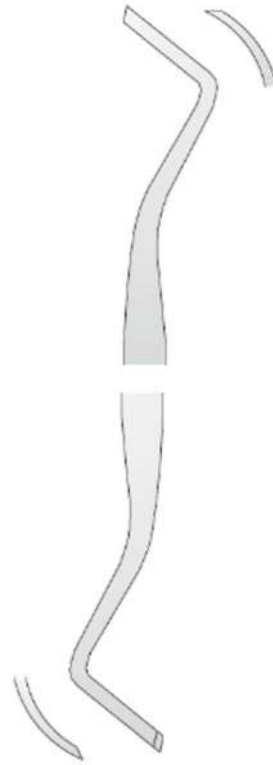

**337450**  
Black  
N.28  
Distale

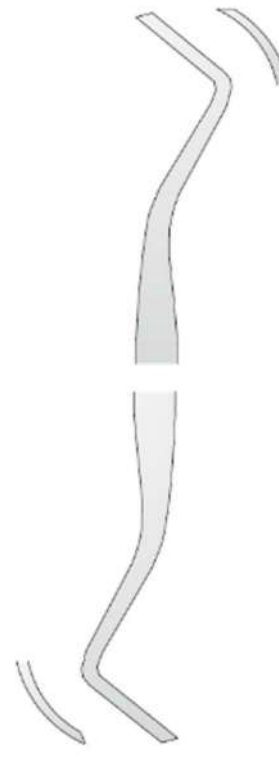

**337455**  
Black  
N.29  
Mesiale

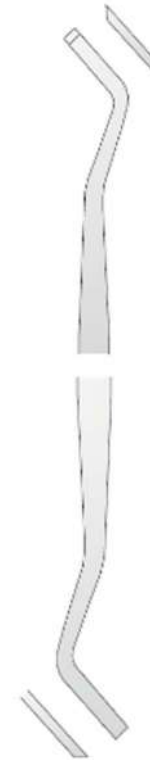

**338420**  
Black  
N.51/52



**338430**  
Black  
N.53/54



Ø 6mm  
SOLID

# Strumenti per SMALTO (Scalpellini)



**338460**  
Wedelstaedt  
1-2



**338470**  
Wedelstaedt  
3-4



**338480**  
Wedelstaedt  
5-6



**339440**  
mm0,5

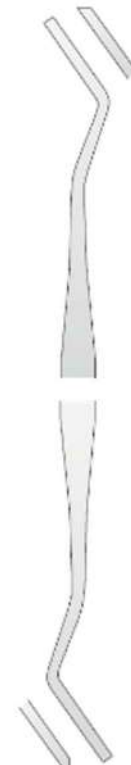

**339450**  
mm1,0



**339460**  
mm1,5

 **SOLID**  
Ø 6mm



# RIFINITORI PER AMALGAMA

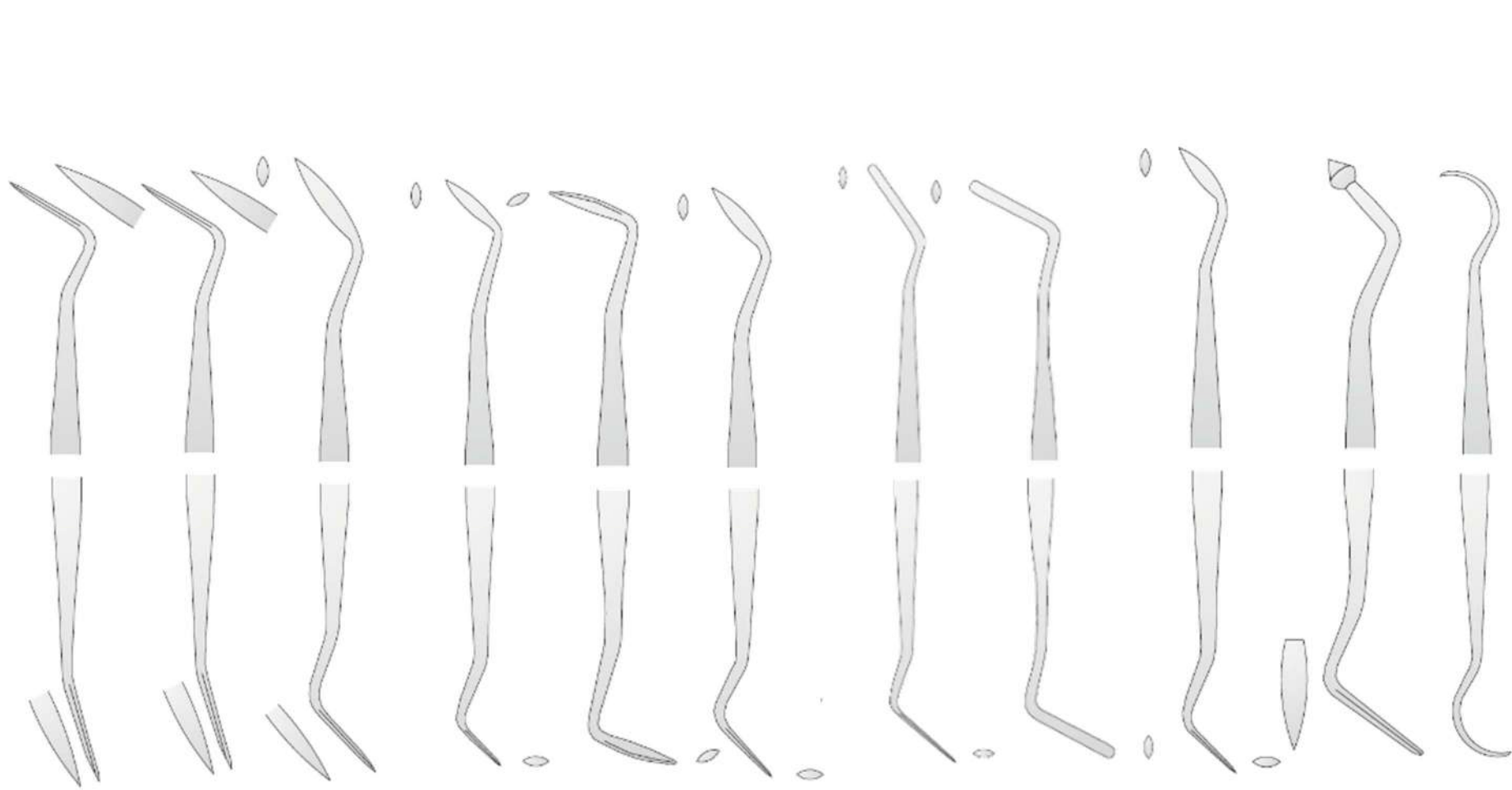

Interprossimali

**342410**  
Ward  
N.1

**342420**  
Ward  
N.1S

**342430**  
Ward  
N.2

**342440**  
Hollenback  
N.1/2

**342450**  
Hollenback  
N.3

**342460**  
Hollenback  
N.3S

**342470**  
IPC1

**342480**  
Off-Angle

**343420**  
N. 104

**343440**  
SHO-A

**343450**  
Wiland  
N.8



Ø 6mm  
SOLID

# RIFINITORI PER AMALGAMA

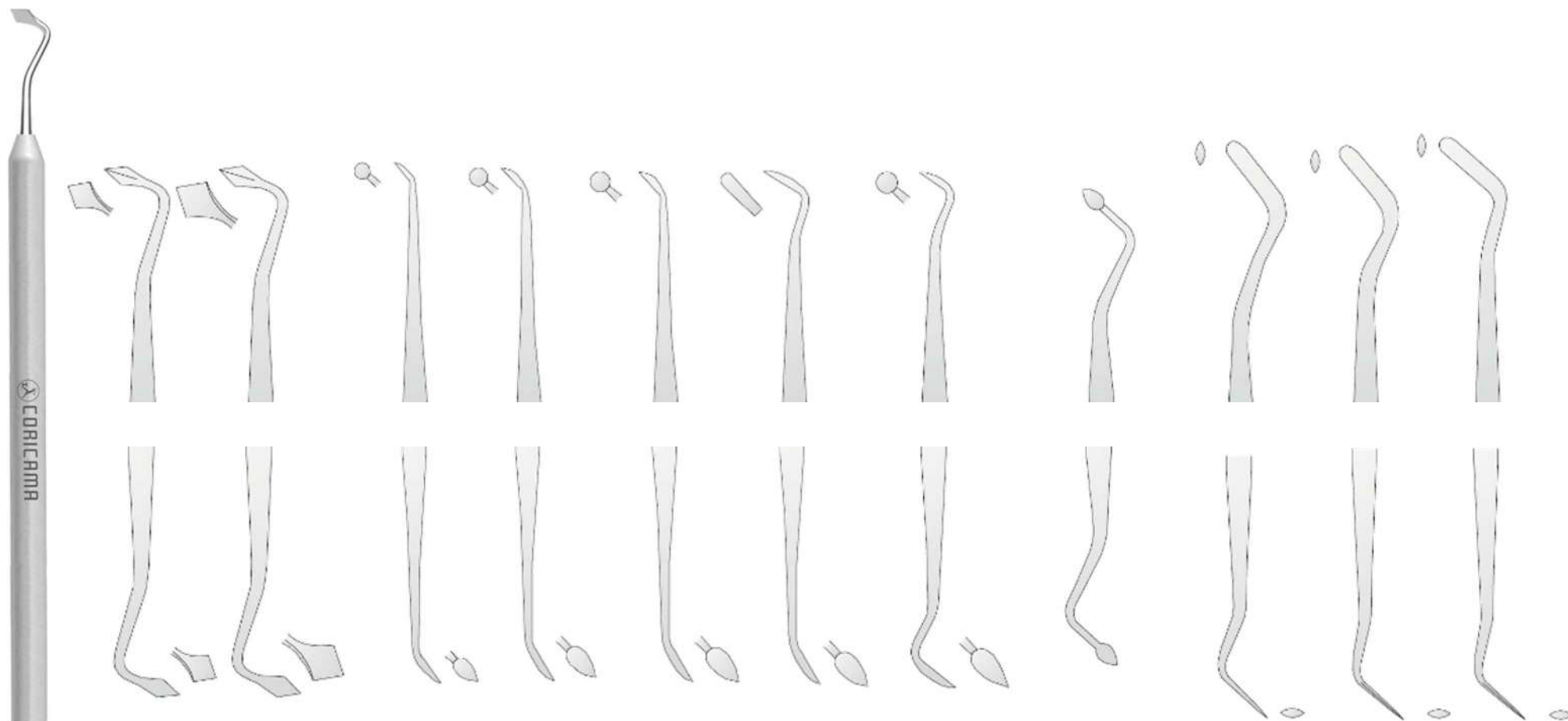

Cleioide - Discoide

<b>343470</b>	<b>343480</b>	<b>344410</b>	<b>344420</b>	<b>344430</b>	<b>344440</b>	<b>344450</b>	<b>344470</b>	<b>345420</b>	<b>345430</b>	<b>345440</b>
Frahm	Frahm				WACD			Nystrom	Nystrom	Nystrom
N. 0/1	N. 2/3	N. 0	N. 89/92	N. 4/5		N. 3/6	N. 110	N.1	N.2	N.3
		mm1,7/1,7	mm2,0/2,4	mm2,5/2,0	mm2,1/2,6	mm2,7/3,0	mm2,0/2,0			

----- CONSERVATIVA 315

CORICAMA

SOLID  
Ø 6mm

# Strumenti per AMALGAMA

## SPINGI AMALGAMA



**347320**  
Medio/  
Piccolo  
mm200\*  
2,0/1,5

**347330**  
Medio/  
Grande  
mm200\*  
2,0/2,5

**347340**  
Medio/  
Extra-Large  
mm200\*  
2,0/3,0

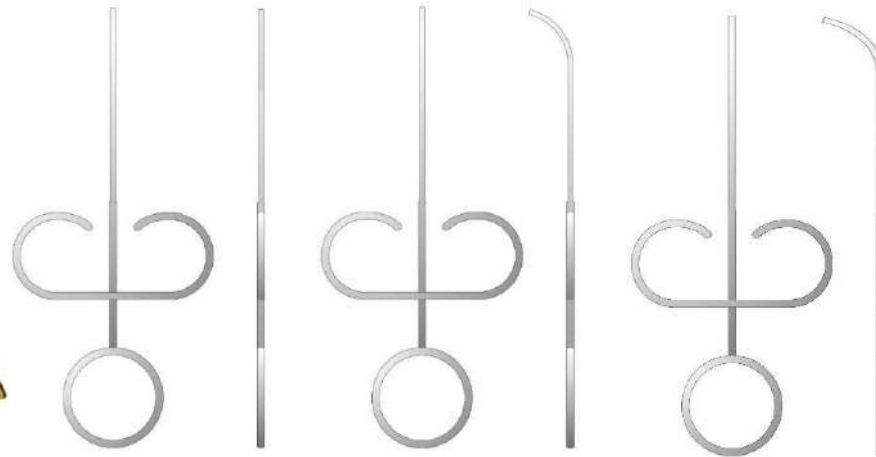

**347220**  
Retta  
mm130\*1,2

**347230**  
Curva  
mm130\*1,2

**347240**  
Curva  
mm130\*1,8



**349920**  
VETRO DI  
SUPPORTO  
mm150\*80\*15

**349930**  
LAMPADA  
AD  
ALCOOL



**349931**  
STOPPINI DI  
RICAMBIO

## SPINGI AMALGAMA



**348210**  
Angolato  
15°  
mm145

**348220**  
Angolato  
45°  
mm140

**348230**  
Angolato  
90°  
mm125

# ESCAVATORI

317

CONSERVATIVA

CORICAMA



Ø 6mm  
SOLID



OVALE



**353410**

17W  
mm1,2



**353420**

18W  
mm1,5



**353430**

19W  
mm2



**353490**

14  
mm1,5



**353450**

17  
mm1,2



**353460**

18  
mm1,5



**353480**

19  
mm2



**354420**

31L  
mm1,25



**354430**

32L  
mm1,5



**354440**

33L  
mm2



OVALE



**355430**

N.2  
mm1,4



**355440**

N.3  
mm1,6



**355450**

N.4  
mm1,8

RIMOZIONE DELLA DENTINA

**355400**  
KIT ESCAVATORI



# ESCAVATORI

# Strumenti per SOTTOFONDO



**356420**  
N.133/134  
mm1



**356430**  
N.129/130  
mm1,8



**356440**  
N.127/128  
mm2



**356450**  
N.125/126  
mm2,5

CUCCHIAIO



**356470**  
NYU E1  
mm1,2

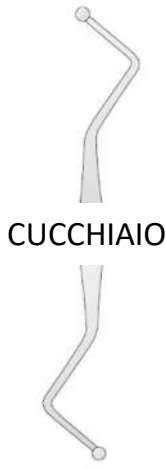

CUCCHIAIO

**356480**  
NYU E2  
mm1,5

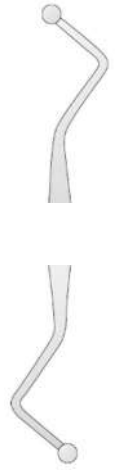

**356490**  
NYU E3  
mm2,5



**359490**  
POSIZIONATORE,  
STRUMENTO DI  
RIPORTO



**359495**  
POSIZIONATORE,  
STRUMENTO DI  
RIPORTO



**359790**  
POSIZIONATORE,  
STRUMENTO DI  
RIPORTO

# Pinze per PONTI e CORONE



**362210**  
SUPERIORE  
mm160

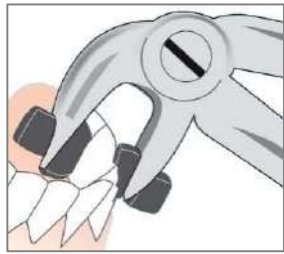

Per la rimozione  
di ponti e  
corone in  
ceramica e  
plastica



**362211**  
GOMMINI RICAMBIO (2 PZ)  
Autoclavabili fino a 180°C



**362220**  
INFERIORE  
mm145

Pinza universale  
per la rimozione di  
ponti e corone in  
ceramica con vite  
di posizionamento  
e molla interna



**362251**  
GOMMINI DI RICAMBIO (6 PZ)  
Autoclavabili fino a 180°C



**362250**  
UNIVERSALE  
mm140

# Pinze per PONTI e CORONE



Per collocare e rimuovere ponti e corone in spazi molto ristretti.

**362271**  
PINZA PER CORONE WYNMAN  
TC - Insetti Carbuoro-Tungsteno  
mm160



**362280**  
PINZA FURRER  
RETTA  
mm150



**362285**  
PINZA FURRER  
ANGOLARE  
mm150



Per corone telescopiche

**362295**  
PINZA BOHM  
Diamantata  
mm150

# Strumenti per PONTI e CORONE

Levacorone doppio predisposto per l'utilizzo di 2 differenti punte contemporaneamente (una per ogni lato)



**364510**  
PUNTA  
N.1

**364520**  
PUNTA  
N.2

**364530**  
PUNTA  
N.3

**364505**  
LEVACORONE  
DOPPIO  
mm180

**364500**  
KIT  
LEVACORONE  
DOPPIO  
mm180  
+ PUNTE 1-2-3



**364710**  
PUNTA  
N.1

**364720**  
PUNTA  
N.2

**364705**  
LEVACORONE  
AUTOMATICO  
mm150

**364700**  
KIT  
CROWN REMOVER  
AUTOMATIC  
mm150  
+ PUNTE 1-2

Per aprire e rimuovere la corona in modo semplice e veloce. Inserire le punte zigriate nel solco (precedentemente creato con una fresa) ed azionare la pinza.



**363410**  
PINZA  
APRICORONE  
mm150



**363450**  
UNIVERSALE  
N.1



**363460**  
UNIVERSALE  
N.2



**363470**  
UNIVERSALE  
N.3



# MATRICI & PORTAMATRICI

## UNIVERSALE

**367110**  
mm5x1000



**367120**  
mm6x1000



**367130**  
mm7x1000



## MOLARI

**367170**  
IVORY mm0,05  
12 PCS



**367180**  
IVORY mm0,05  
12 PCS



**367190**  
IVORY mm0,05  
12 PCS



## PREMOLARI

**367140**  
IVORY mm0,05  
12 PCS



**367150**  
IVORY mm0,05  
12 PCS



**367160**  
IVORY mm0,05  
12 PCS



## MOLARI E PREMOLARI

**367260**  
TOFFLEMIRE mm0,05  
12 PCS



**367270**  
TOFFLEMIRE mm0,05  
12 PCS



**367280**  
TOFFLEMIRE mm0,05  
12 PCS



**366130**  
SIQUELAND  
STRETTO  
mm5-6-7



**366140**  
SIQUELAND  
LARGO  
mm5-6-7



**366150**  
IVORY  
8N  
mm5-6-7



**366170**  
DIDNER  
8P  
mm5-6



**366180**  
TOFFLEMIRE  
UNIVERSALE  
mm5-6-7



**366185**  
TOFFLEMIRE  
JUNIOR  
mm5



**366190**  
IVORY  
N12





**CORICAMA**<sup>®</sup>  
since 1873

ENDODONZIA

# Strumenti per ENDODONZIA



**370040**  
PINZA PER PERNI  
CANALARI

mm135



**370050**  
PINZA PER PERNI  
CANALARI CURVA

mm140



**370080**  
CON SISTEMA  
DI BLOCCO  
SCANALATA

mm150



**375890**  
MICRO  
SPECILLO

mm205\*0,5



**375895**  
MICRO  
SPECILLO  
ANGOLATO

mm195\*0,5

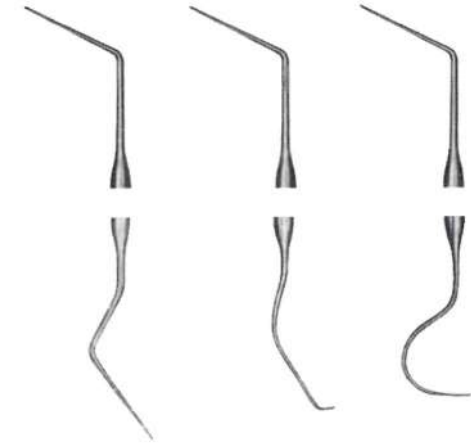

**376420**  
SPECILLO  
DG 6/6A

**376430**  
SPECILLO  
DG 6/17

**376440**  
SPECILLO  
DG 6/23

# PLUGGERS



**384420**  
1/3  
mm0,4/0,45



**384430**  
5/7  
mm0,5/0,75



**384440**  
9/11  
mm1,0/1,15



**383720**  
ISO 60  
mm0,6



**383740**  
ISO 80  
mm0,8



**SOLID**  
Ø 6mm



**384460**  
Lama/Otturatore  
GLICK  
mm1,1

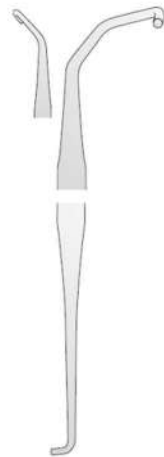

**384470**  
Otturatore  
posteriore N.1  
mm0,8

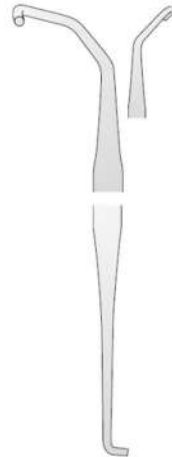

**384480**  
Otturatore  
posteriore N.2  
mm1,1



**383760**  
ISO 100  
mm1



**383780**  
ISO 120  
mm1,2

# SPREADERS



SOLID  
∅ 6mm



**388720**  
ISO 20



**388740**  
ISO 30



**386420**  
FIG. 1S



**386430**  
FIG. 2S



**386440**  
FIG. D-11



**388760**  
ISO 40



**388780**  
ISO 50



**386450**  
FIG. MA 57



**386460**  
FIG. 0



**386470**  
FIG. 00



**386480**  
FIG. 3

# CONTENITORI PER ENDODONZIA

PICCOLO 104\*44\*54mm



**399113**

ALLUMINIO

Per: 72

Strumenti  
endodontici

**399133**

ALLUMINIO

Per: 48

Strumenti  
endodontici

**399183**

ALLUMINIO

Per: 12

Punte



**399613**

PULITORE STRUMENTI  
CANALARI - ALLUMINIO  
mm30\*ø40

**399614**

SPUGNA DI RICAMBIO

MEDIO  
125\*105\*54mm

**399323**

ALLUMINIO

Con 5 inserti intercambiabili

Per: 3\*72

Strumenti endodontici



GRANDE  
204\*105\*54mm

**399373**

ALLUMINIO

Per: 357

Strumenti endodontici  
e 21

Punte

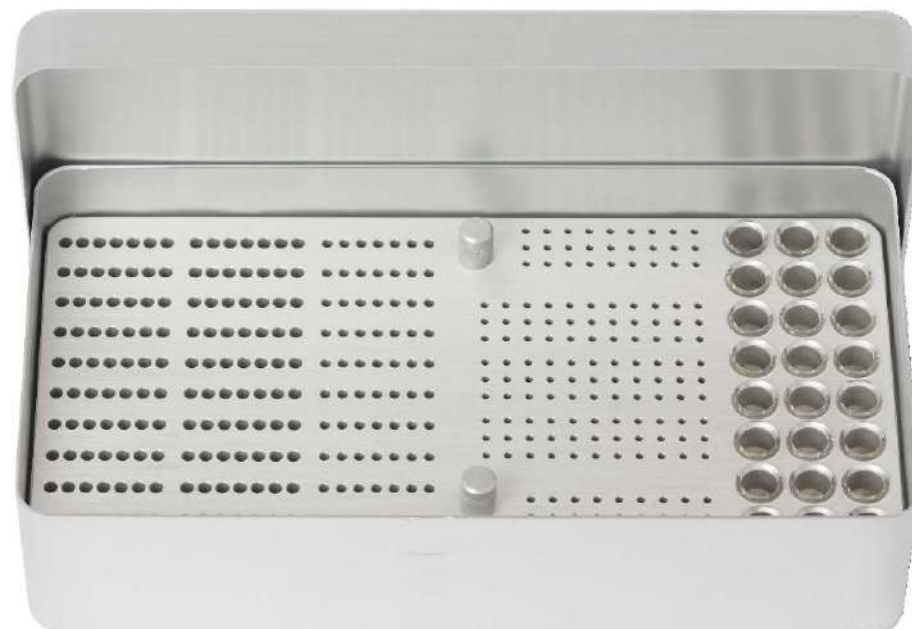

# CONTENITORI PER ENDODONZIA



**399713**  
PORTA FRESE FG-24  
CON COPERCHIO

ALLUMINIO  
24 Piccoli  
mm62\*42\*37

**399723**  
PORTA FRESE RA-24  
CON COPERCHIO

ALLUMINIO  
24 Grandi  
mm60\*42\*37

**399733**  
PORTA FRESE FG/RA-24  
CON COPERCHIO

ALLUMINIO  
12 Piccoli / 12 Grandi  
mm60\*42\*37

**399753**  
PORTA FRESE FG-36  
CON COPERCHIO

ALLUMINIO  
36 Piccoli  
mm60\*50\*37

**399763**  
PORTA FRESE RA-36  
CON COPERCHIO

ALLUMINIO  
36 Grandi  
mm60\*50\*37

**399773**  
PORTA FRESE FG/RA-36  
CON COPERCHIO

ALLUMINIO  
18 Piccoli / 18 Grandi  
mm60\*50\*37



**399913**  
VASSOIO PER ENDODONZIA ALLUMINIO  
CON COPERCHIO - mm257\*116\*16



**399943**  
PORTA FRESE  
FG-48 ALLUMINIO  
48 Piccoli  
mm75\*40

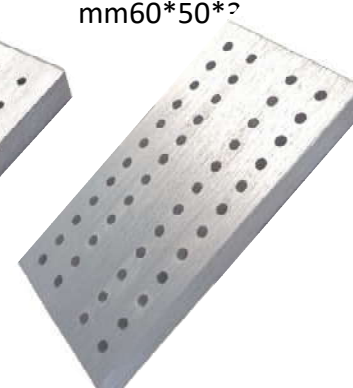

**399963**  
PORTA FRESE  
RA-48 ALLUMINIO  
48 Grandi  
mm75\*40

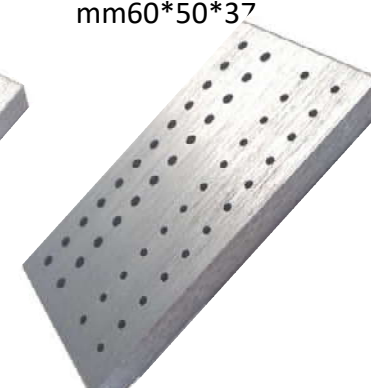

**399983**  
PORTA FRESE  
FG/RA-48 ALLUMINIO  
24 Piccoli / 24 Grandi  
mm75\*40





**CORICAMA**<sup>®</sup>  
since 1873

IMPIANTOLOGIA

# OSTEOTOMI Doppio Fissaggio – Convessi

Retto

Baionetta

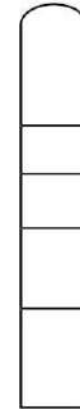
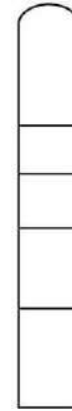
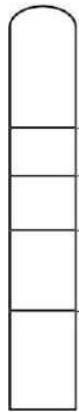

**412120**  
mm2.7

**412125**  
mm3.2

**412130**  
mm3.7

**412160**  
mm2.7

**412165**  
mm3.2

**412170**  
mm3.7

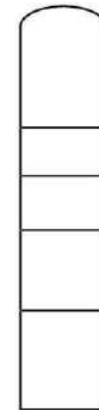
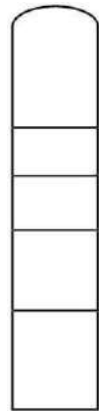
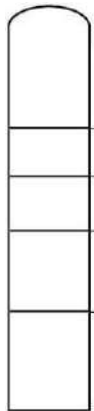

6 mm  
8 mm  
11 mm  
15 mm

6 mm  
8 mm  
11 mm  
15 mm

6 mm  
8 mm  
11 mm  
15 mm

6 mm  
8 mm  
11 mm  
15 mm

**412199**  
DISPOSITIVO  
DI  
BLOCCAGGIO

mm160

**412135**  
mm4.2

**412140**  
mm5.0

**412175**  
mm4.2

**412180**  
mm5.0

mm165

# OSTEOTOMI Doppio Fissaggio – Concavi

## Retto

## Baionetta



**412220**  
mm2.7

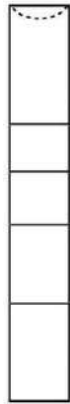

**412225**  
mm3.2

6 mm  
8 mm  
11 mm  
15 mm

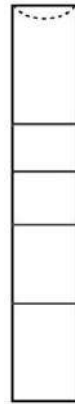

**412230**  
mm3.7

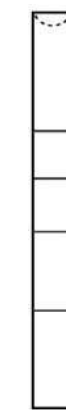

**412260**  
mm2.7



**412265**  
mm3.2

6 mm  
8 mm  
11 mm  
15 mm

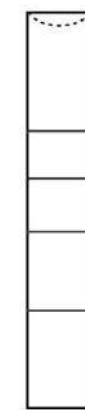

**412270**  
mm3.7



6 mm  
8 mm  
11 mm  
15 mm

**412235**  
mm4.2

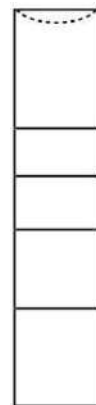

6 mm  
8 mm  
11 mm  
15 mm

**412240**  
mm5.0



**412199**  
DISPOSITIVO  
DI  
BLOCCAGGIO

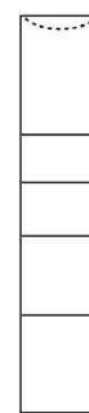

6 mm  
8 mm  
11 mm  
15 mm

**412275**  
mm4.2

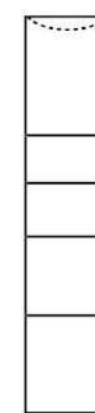

6 mm  
8 mm  
11 mm  
15 mm

**412280**  
mm5.0



mm165

# OSTEOTOMI – Dilatatori del Sito Implantare



mm155

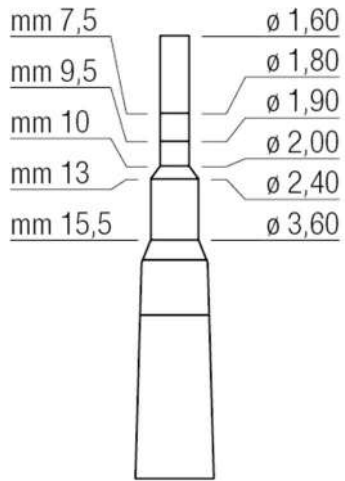

**414110**  
mm1.6/3.6

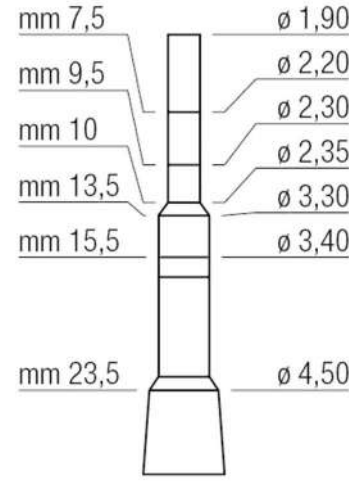

**414120**  
mm1.9/4.5

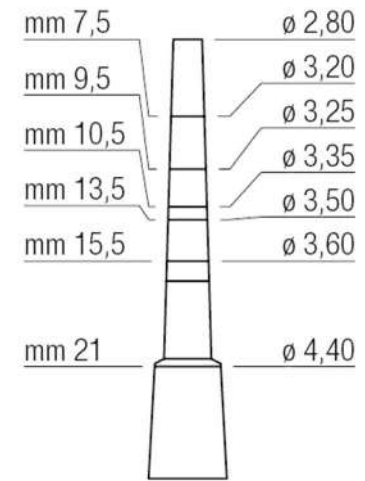

**414130**  
mm2.8/4.4

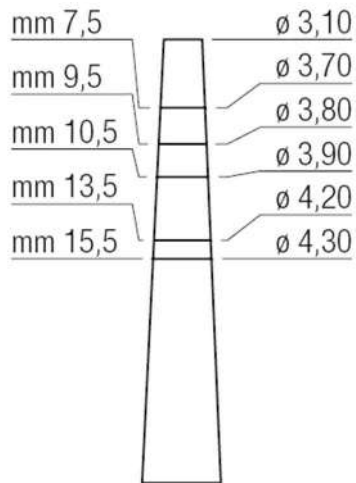

**414140**  
mm3.1/4.3

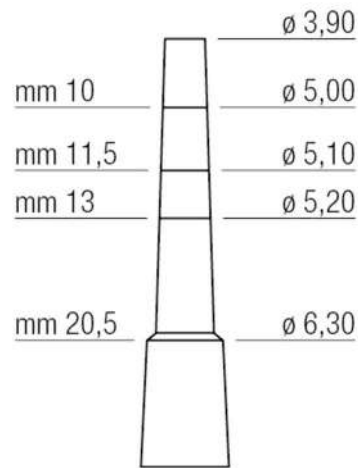

**414150**  
mm3.9/6.3

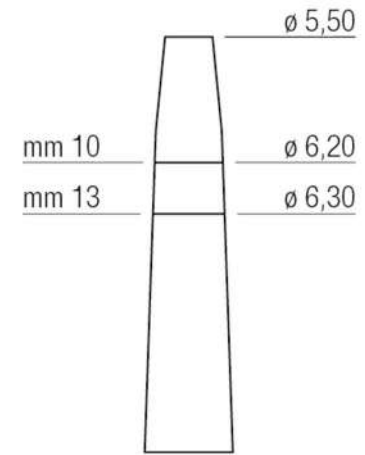

**414160**  
mm5.5/6.3

# Strumenti per il RIALZO DEL SENO MASCELLARE



**421500**  
KIT STRUMENTI  
RIALZO SENO  
MASCELLARE

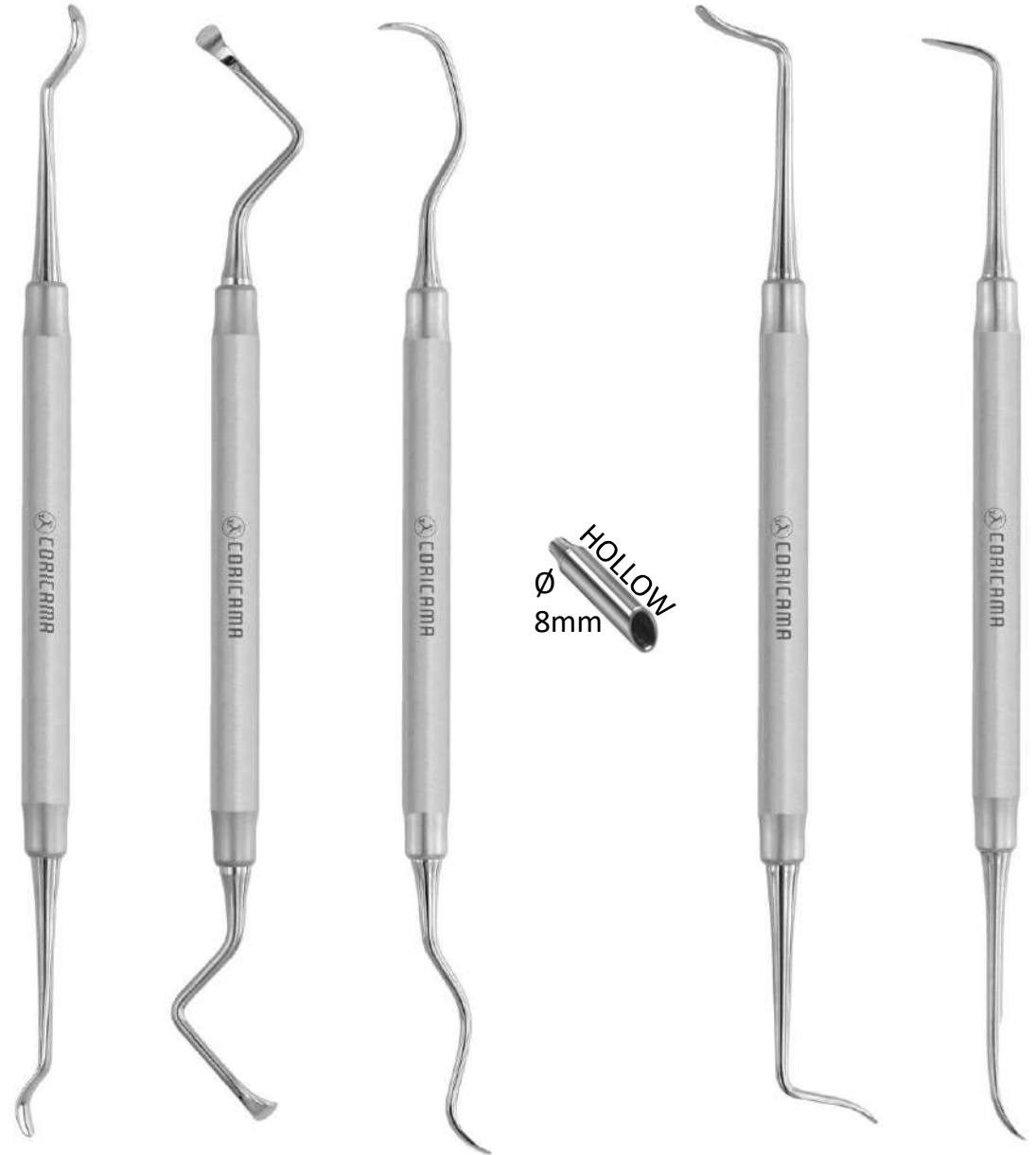

**421510**  
N.901

**421520**  
N.902

**421530**  
N.903

**421540**  
N.904

**421550**  
N.905

# Strumenti per il RIALZO DEL SENO MASCELLARE



**422510**

N.1

**422520**

N.2

**422530**

N.3

**422540**

N.4

**422550**

N.5

**422560**

N.6

**422570**

BUSER

N.7

**422580**

BUSER

N.8

**422590**

BUSER

N.9

# Strumenti per TRATTAMENTO DELL'OSSO

## Grattino per Osso

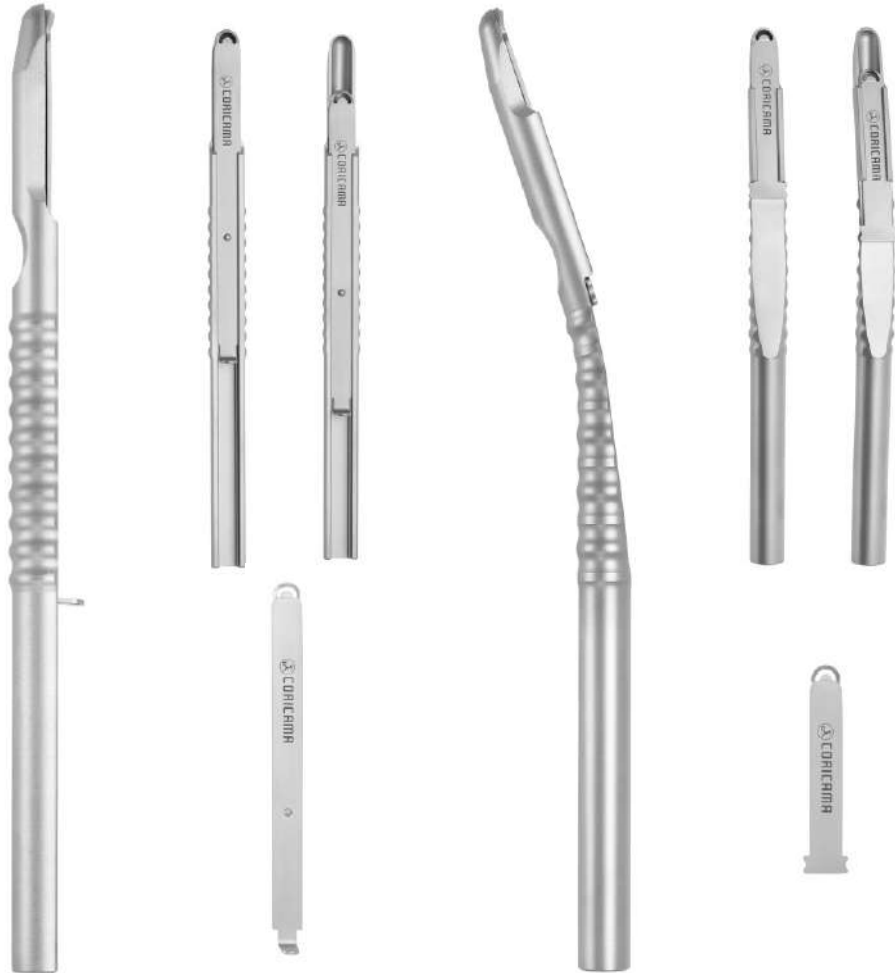

**441110**  
GRATTINO PER  
OSSO RETTO

**441115**  
GRATTINO PER  
OSSO RETTO  
LAMA DI  
RICAMBIO

**441120**  
GRATTINO PER  
OSSO ANGOLATO

**441125**  
GRATTINO PER  
OSSO ANGOLATO  
LAMA DI  
RICAMBIO

## Raccoglitori per Osso



**473520**  
CUCCHIAIO E  
COMPATTATORE  
PER OSSO  
BSP1

**471110**  
CUCCHIAIO  
PER OSSO  
mm155

**445212**  
VASSOIO MINI  
TITANIO

**445320**  
MORTAIO  
PER OSSO

# Strumenti per TRATTAMENTO DELL'OSSO

## Macinatore per Osso



**445512**  
PINZA OSSIVORA  
MACINATORE PER OSSO  
TITANIO



**445410**  
MACINATORE  
PER OSSO  
mm40

## Iniettori d'Osso



**447120**  
mm2.5



**447125**  
mm3.5



**447130**  
mm4.4

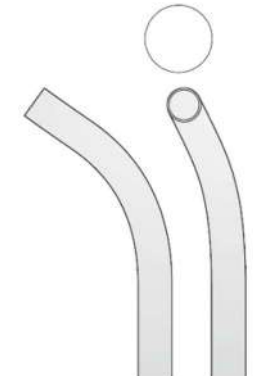

**447135**  
mm7.0

## Iniettori d'Osso con Imbuto



**447150**  
mm2.5



**447155**  
mm3.5



**447160**  
mm4.4



# Strumenti per TRATTAMENTO DELL'OSSO – SCALPELLI



**452620**  
RETTO  
mm3.8

**452625**  
CURVO  
mm3.8

**452640**  
RETTO  
mm7.5

**452645**  
CURVO  
mm7.5

**453620**  
WAKEFIELD  
1W  
mm3.9

**453630**  
WAKEFIELD  
2W  
mm4.9

**453645**  
OCHSENBEIN  
Interno  
mm5

**453655**  
OCHSENBEIN  
Esterno  
mm5

# Strumenti per TRATTAMENTO DELL'OSSO – SCALPELLI



SOLID  
Ø 6mm



**454420**  
SINGOLO  
mm3

**454430**  
DOPPIO  
mm3

**454450**  
SINGOLO  
mm6

**454460**  
DOPPIO  
mm6

**454480**  
SINGOLO  
mm9

**454490**  
DOPPIO  
mm9

# Strumenti per TRATTAMENTO DELL'OSSO

## SCALPELLI Partsch

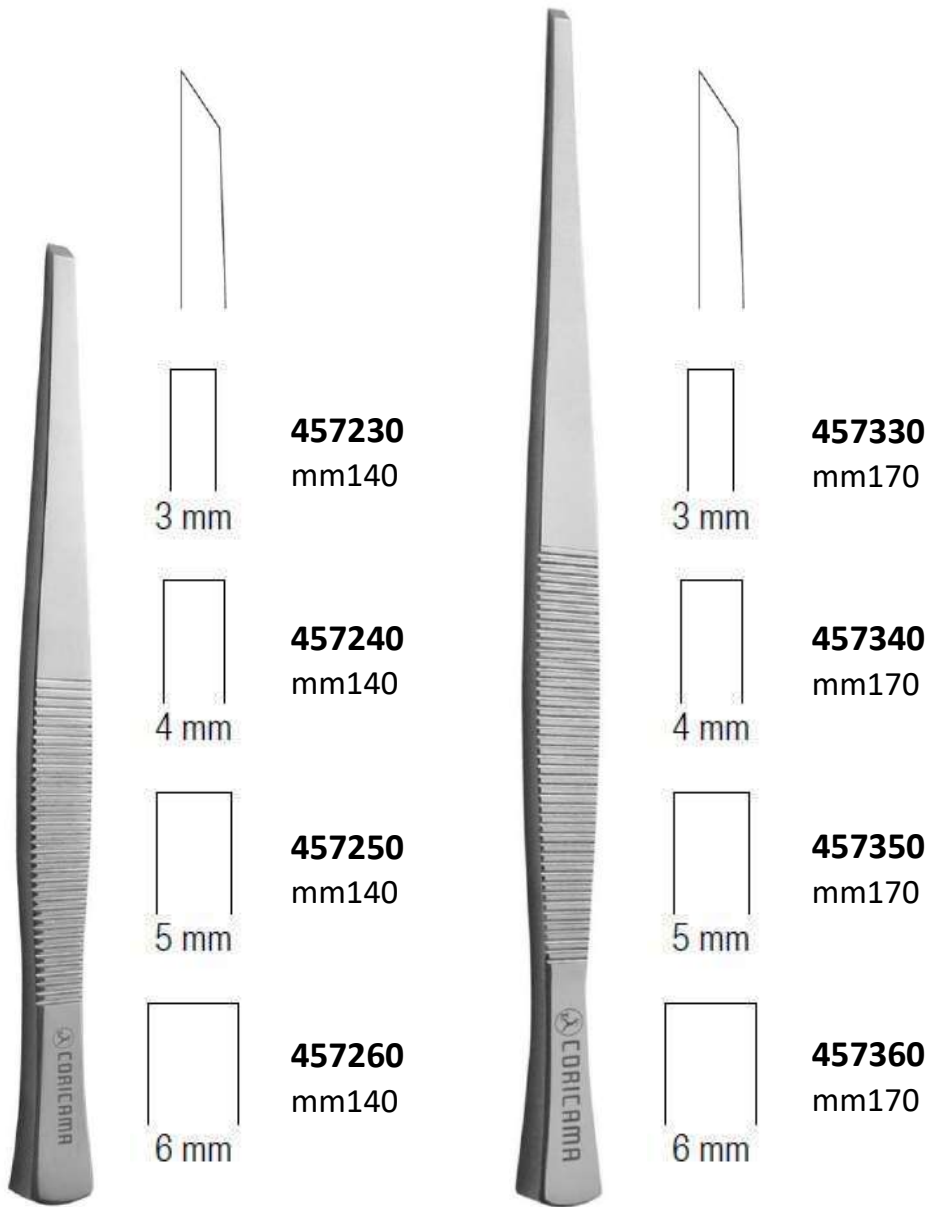

## MARTELLI



# Strumenti per TRATTAMENTO DELL'OSSO



**468210**  
ASPIRATORE PER OSO  
mm12  
\*270



**468512**  
PINZETTE PER  
IMPIANTI  
TITANIO



**475520**  
PLUGGER PER  
OSSO BP1  
mm3



**475530**  
PLUGGER PER  
OSSO BP2  
mm3-5



**475740**  
COMPATTATORE  
PER OSO  
mm3-4



**475750**  
COMPATTATORE  
PER OSO  
mm6-8

# Strumenti per TRATTAMENTO DELL'OSSO – CALIBRI

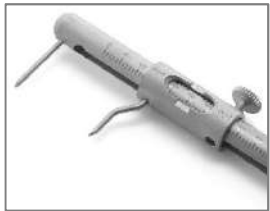

**882510**  
CALIBRO MSY

mm125



**882110**  
SPESSIMETRO

mm145



**882210**  
SPESSIMETRO

mm155



**882410**  
CALIBRO CASTROVIEJO

mm180



**882420**  
CALIBRO CASTROVIEJO  
CURVO

mm180



**882640**  
PROFONDIMETRO





**CORICAMA**<sup>®</sup>  
since 1873

CHIRURGIA

# MANICO BISTURI PORTA LAME



**515160**

N.4

Per lame  
tipo No.4

mm135



**515120**

N.3

Per lame  
tipo No.3

mm125



**515140**

N.3

Bard Parker  
Per lame  
tipo No.3  
Graduato  
(mm)

mm125



**515180**

N.7

Per lame  
tipo No.3  
Manico sottile

mm165



**515530**

Retto

Per lame  
tipo No.3  
Design  
Ergonomico

mm145



**515535**

Curvo

Per lame  
tipo No.3  
Design  
Ergonomico

mm145



**515630**

ORIENTABILE

Lungo

Per lame  
tipo No.3  
orientabile su 7  
posizioni e 180°

mm160



**515635**

ORIENTABILE

Corto

Per lame  
tipo No.3  
orientabile su 7  
posizioni e 180°

mm110



# LAME PER BISTURI

LAME PER BISTURI  
per  
PORTA LAME → Per lame tipo No.3



**518110**  
LAME BISTURI  
STERILI - N.11  
Appuntita  
Confezione da  
100 pz



**518120**  
LAME BISTURI  
STERILI - N.12  
Curva  
Confezione da  
100 pz



**518130**  
LAME BISTURI  
STERILI - N.13  
Arrotondata  
Confezione da  
100 pz



**518155**  
LAME BISTURI  
STERILI - N.15C  
Arrotondata  
Confezione da  
100 pz

Altre modelli di LAME PER BISTURI  
sono disponibili su richiesta



**518220**  
MICRO LAME  
STERILE - N.64  
Arrotondata  
Confezione da  
25 pz



**518240**  
MICRO LAME  
STERILE - N.65  
Appuntita  
Confezione da  
25 pz



**518260**  
MICRO LAME  
STERILE - N.67  
Arrotondata  
Confezione da  
25 pz



**518280**  
MICRO LAME  
STERILE - N.69  
Arrotondata  
Confezione da  
25 pz



MICRO - SPECCHIETTI  
e  
MICRO - LAME



**112030**  
MANICO MOD. LISCIO  
112010  
Manico Zigrinato

# PORTA AGHI



**520240**  
Barraquer  
Retta

Per aghi:  
4-0, 5-0, 6-0  
mm160



**520241**  
Barraquer  
Retta  
TC – Insetti in  
Carburo di Tungsteno

Per aghi:  
4-0, 5-0, 6-0  
mm160



**520250**  
Barraquer  
Curva

Per aghi:  
4-0, 5-0, 6-0  
mm160



**520251**  
Barraquer  
Curva  
TC – Insetti in  
Carburo di Tungsteno

Per aghi:  
4-0, 5-0, 6-0  
mm160

# PORTA AGHI – Castroviejo

Castroviejo con manico arrotondato, zigrinato



**520320**

Retta

Per aghi:  
4-0, 5-0, 6-0  
mm140

**520321**

Retta

TC – Insetti in  
Carburo di  
Tungsteno

Per aghi:  
4-0, 5-0, 6-0  
mm140

**520330**

Curva

Per aghi:  
4-0, 5-0, 6-0  
mm140

**520331**

Curva

TC – Insetti in  
Carburo di  
Tungsteno

Per aghi:  
4-0, 5-0, 6-0  
mm140

**520370**

Retta

Per aghi:  
4-0, 5-0, 6-0  
mm180

**520371**

Retta

TC – Insetti in  
Carburo di  
Tungsteno

Per aghi:  
4-0, 5-0, 6-0  
mm180

**520380**

Curva

Per aghi:  
4-0, 5-0, 6-0  
mm180

**520381**

Curva

TC – Insetti in  
Carburo di  
Tungsteno

Per aghi:  
4-0, 5-0, 6-0  
mm180

# PORTA AGHI – Castroviejo

Castroviejo con manico piatto, zigrinato



**520420**  
Retta

Per aghi:  
4-0, 5-0, 6-0  
mm140



**520421**  
Retta  
TC – Insetti in  
Carburo di  
Tungsteno

Per aghi:  
4-0, 5-0, 6-0  
mm140



**520430**  
Curva

Per aghi:  
4-0, 5-0, 6-0  
mm140



**520431**  
Curva  
TC – Insetti in  
Carburo di  
Tungsteno

Per aghi:  
4-0, 5-0, 6-0  
mm140



**520470**  
Retta

Per aghi:  
4-0, 5-0, 6-0  
mm180



**520471**  
Retta  
TC – Insetti in  
Carburo di  
Tungsteno

Per aghi:  
4-0, 5-0, 6-0  
mm180



**520480**  
Curva

Per aghi:  
4-0, 5-0, 6-0  
mm180



**520481**  
Curva  
TC – Insetti in  
Carburo di  
Tungsteno

Per aghi:  
4-0, 5-0, 6-0  
mm180

# PORTA AGHI – Mathieu



**520520**

Retta, Sottile

Per aghi:  
2-0, 3-0, 4-0  
mm140

**520521**

Retta, Sottile

TC - Inserti  
Carburo  
Tungsteno

Per aghi:  
2-0, 3-0, 4-0  
mm140

**520530**

Retta

Per aghi:  
2-0, 3-0, 4-0  
mm140

**520531**

Retta

TC - Inserti  
Carburo  
Tungsteno

Per aghi:  
2-0, 3-0, 4-0  
mm140

**520560**

Retta, Sottile

Per aghi:  
2-0, 3-0, 4-0  
mm170

**520561**

Retta, Sottile

TC - Inserti  
Carburo  
Tungsteno

Per aghi:  
2-0, 3-0, 4-0  
mm170

**520570**

Retta

Per aghi:  
2-0, 3-0, 4-0  
mm170

**520571**

Retta

TC - Inserti  
Carburo  
Tungsteno

Per aghi:  
2-0, 3-0, 4-0  
mm170

# PORTA AGHI – Con Forbice



**520640**  
Mathieu-Olsen  
Retta, Scanalata

Per aghi:  
2-0, 3-0, 4-0, 5-0  
mm170



**520641**  
Mathieu-Olsen  
Retta  
TC - Inerti Carburio  
Tungsteno

Per aghi:  
2-0, 3-0, 4-0, 5-0  
mm170



**520660**  
Gilles  
Curva, Scanalata

Per aghi:  
2-0, 3-0, 4-0, 5-0  
mm160



**520661**  
Gilles  
Curva  
TC - Inerti Carburio  
Tungsteno

Per aghi:  
2-0, 3-0, 4-0, 5-0  
mm160



**520670**  
Olsen-Hegar  
Retta

Per aghi:  
3-0, 4-0, 5-0  
mm140



**520671**  
Olsen-Hegar  
Retta  
TC - Inerti Carburio  
Tungsteno

Per aghi:  
3-0, 4-0, 5-0  
mm140

# PORTA AGHI – Mayo-Hegar



**520720**

Mayo-Hegar  
Retta, Scanalata

Per aghi:  
2-0, 3-0, 4-0  
mm130

**520721**

Mayo-Hegar  
Retta  
TC - Inserti  
Carburo  
Tungsteno

Per aghi:  
2-0, 3-0, 4-0  
mm130

**520740**

Mayo-Hegar  
Retta, Scanalata

Per aghi:  
2-0, 3-0, 4-0  
mm160

**520741**

Mayo-Hegar  
Retta  
TC - Inserti  
Carburo  
Tungsteno

Per aghi:  
2-0, 3-0, 4-0  
mm160

**520770**

Mayo-Hegar  
Retta, Scanalata

Per aghi:  
2-0, 3-0, 4-0  
mm180

**520771**

Mayo-Hegar  
Retta  
TC - Inserti  
Carburo  
Tungsteno

Per aghi:  
2-0, 3-0, 4-0  
mm180

**520790**

Mayo-Hegar  
Retta, Scanalata

Per aghi:  
2-0, 3-0, 4-0  
mm200

**520791**

Mayo-Hegar  
Retta  
TC - Inserti  
Carburo  
Tungsteno

Per aghi:  
2-0, 3-0, 4-0  
mm200

# PORTA AGHI – Crile-Ryder

Crile-Ryder con punte sottili



**520830**  
Crile-Ryder  
Retta, Sottile

Per aghi:  
3-0, 4-0, 5-0, 6-0  
mm130

**520831**  
Crile-Ryder  
Retta, Sottile  
TC - Inerti Carburio  
Tungsteno

Per aghi:  
3-0, 4-0, 5-0, 6-0  
mm130

**520840**  
Crile-Ryder  
Retta, Sottile

Per aghi:  
3-0, 4-0, 5-0, 6-0  
mm150

**520841**  
Crile-Ryder  
Retta, Sottile  
TC - Inerti Carburio  
Tungsteno

Per aghi:  
3-0, 4-0, 5-0, 6-0  
mm150

**520850**  
Crile-Ryder  
Retta, Sottile

Per aghi:  
3-0, 4-0, 5-0, 6-0  
mm180

**520851**  
Crile-Ryder  
Retta, Sottile  
TC - Inerti Carburio  
Tungsteno

Per aghi:  
3-0, 4-0, 5-0, 6-0  
mm180



# PORTA AGHI



**520860**

Crile-Wood  
Retta

Per aghi:  
3-0, 4-0, 5-0, 6-0  
mm150

**520861**

Crile-Wood  
Retta

TC - Inerti Carburio  
Tungsteno

Per aghi:  
3-0, 4-0, 5-0, 6-0  
mm150

**520871**

Crile-Wood  
Curva

TC - Inerti Carburio  
Tungsteno

Per aghi:  
3-0, 4-0, 5-0, 6-0  
mm150

**520880**

Adson  
Retta, Forata

Per aghi:  
1-0, 2-0, 3-0, 4-0  
mm170

**520920**

Derf  
Retta

Per aghi:  
3-0, 4-0, 5-0  
mm120

**520921**

Derf  
Retta

TC - Inerti Carburio  
Tungsteno

Per aghi:  
3-0, 4-0, 5-0  
mm120

# PORTA AGHI



**520930**  
Baumgartner  
Retta

Per aghi:  
2-0, 3-0, 4-0  
mm130



**520931**  
Baumgartner  
Retta  
TC - Inerti Carbuoro  
Tungsteno

Per aghi:  
2-0, 3-0, 4-0  
mm130



**520940**  
Halsey  
Retta

Per aghi:  
2-0, 3-0, 4-0  
mm130



**520941**  
Halsey  
Retta  
TC - Inerti Carbuoro  
Tungsteno

Per aghi:  
2-0, 3-0, 4-0  
mm130



**520950**  
Fine Swedish  
Retta

Per aghi:  
5-0, 6-0, 7-0, 8-0  
mm150



**520951**  
Fine Swedish  
Retta  
TC - Inerti Carbuoro  
Tungsteno

Per aghi:  
5-0, 6-0, 7-0, 8-0  
mm150

# FORBICI

## IDENTIFICAZIONE DEGLI ELEMENTI DELLE FORBICI:



TC – INSERTI IN CARBURO DI TUNGSTENO:  
elettro-saldati sulle parti taglienti degli  
strumenti con le più avanzate tecnologie.  
Codice colore conforme con gli standard  
internazionali:

**Entrambi i manici sono dorati**



**S/S**

Appuntita /  
Appuntita



**S/B**

Appuntita /  
Arrotondata



**B/B**

Arrotondata /  
Arrotondata



SUPERIOR CUT:

Lama estremamente affilata da  
una parte e lama micro dentata  
dalla parte opposta per garantire  
la presa dei tessuti e un taglio  
perfetto.

**Solo uno dei due manici è dorato**

## IRIS MICRO



**535110**

IRIS MICRO

S/S

Retta

mm90



**535140**

IRIS MICRO

S/S

Curva

mm90

# FORBICI – Iris



**535210**  
IRIS  
S/S

Retta  
mm115



**535211**  
IRIS  
S/S  
TC - Inserti in  
Carburo di  
Tungsteno

Retta  
mm115



**535220**  
IRIS  
S/S  
*SUPERIOR CUT*

Retta  
mm115



**535240**  
IRIS  
S/S

Curva  
mm115



**535241**  
IRIS  
S/S  
TC - Inserti in  
Carburo di  
Tungsteno

Curva  
mm115



**535250**  
IRIS  
S/S  
*SUPERIOR CUT*

Curva  
mm115



**535280**  
IRIS ANGOLATA  
S/S

45°  
mm115

# FORBICI – Goldman-Fox



**536310**

S/S, Micro dentata

Retta  
mm130

**536311**

S/S, Micro dentata

TC - Inerti in  
Carburo di  
Tungsteno

Retta  
mm130

**536320**

S/S

*SUPERIOR CUT*

Retta  
mm130

**536340**

S/S, Micro dentata

Curva  
mm130

**536341**

S/S, Micro dentata

TC - Inerti in  
Carburo di  
Tungsteno

Curva  
mm130

**536350**

S/S

*SUPERIOR CUT*

Curva  
mm130

**536360**

S/S,  
Micro dentata

Doppia Curva  
mm130

# FORBICI



**537260**  
La Grange  
S/S, Dentata

Doppia curva  
mm115



**537261**  
La Grange  
S/S, Dentata  
TC - Inerti in  
Carburo di Tungsteno

Doppia curva  
mm115



**537270**  
La Grange  
S/S  
*SUPERIOR CUT*

Doppia curva  
mm115



**537360**  
Neumann  
S/S, Dentata

Doppia curva  
mm120



**538410**  
Joseph  
S/S

Retta  
mm140



**538440**  
Joseph  
S/S

Curva  
mm140

# FORBICI – Kelly



**538510**  
S/S

Retta  
mm160



**538511**  
S/S  
TC - Inerti in  
Carburo di Tungsteno

Retta  
mm160



**538540**  
S/S

Curva  
mm160



**538541**  
S/S  
TC - Inerti in  
Carburo di Tungsteno

Curva  
mm160



**538550**  
S/S  
*SUPERIOR CUT*

Curva  
mm160

# FORBICI – Metzenbaum



**539410**  
B/B

Retta  
mm145

**539411**  
B/B

TC - Inerti  
Carburo di  
Tungsteno  
Retta  
mm145

**539440**  
B/B

Curva  
mm145

**539441**  
B/B

TC - Inerti  
in Carburo  
Tungsteno  
Curva  
mm145

**539710**  
B/B

Retta  
mm180

**539711**  
B/B

TC - Inerti  
in Carburo  
Tungsteno  
Retta  
mm180

**539740**  
B/B

Curva  
mm180

**539741**  
B/B

TC - Inerti  
in Carburo  
Tungsteno  
Curva  
mm180



# FORBICI – Mayo



**540410**  
Mayo  
B/B  
Retta  
mm140



**540440**  
Mayo  
B/B  
Curva  
mm140



**540510**  
Mayo  
B/B  
Retta  
mm160



**540540**  
Mayo  
B/B  
Curva  
mm160



**540710**  
Mayo  
B/B  
Retta  
mm180



**540740**  
Mayo  
B/B  
Curva  
mm180

# FORBICI

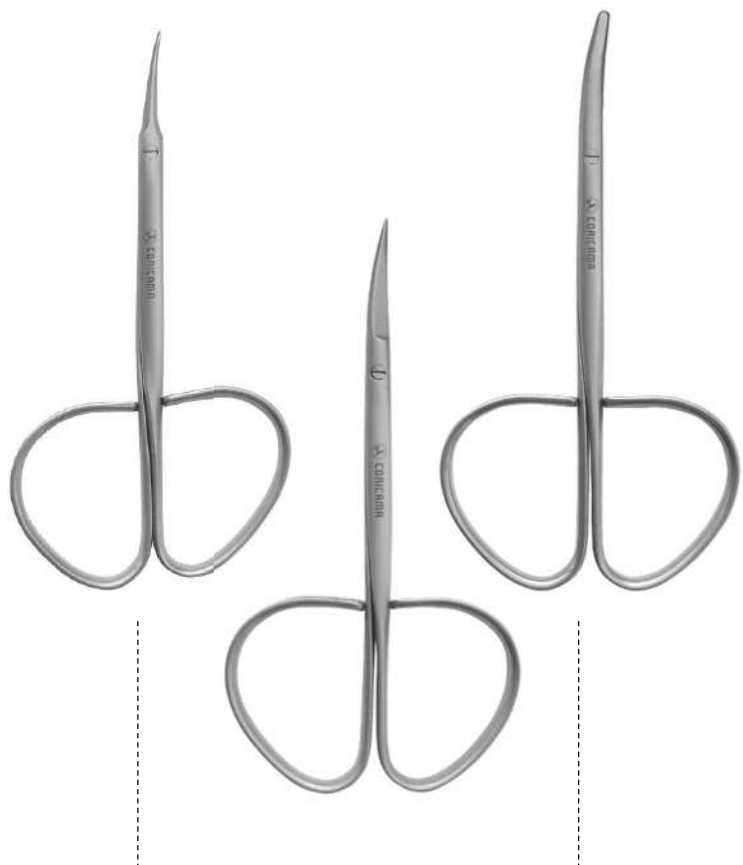

**542140**  
Marilyn  
S/S  
Curva  
mm95

**542220**  
Marilyn  
S/S  
Curva  
mm100

**542240**  
Marilyn  
B/B, Arrotondata  
Curva  
mm100

**543550**  
Locklin  
S/S, Dentata  
Retta, Angolata  
mm160



**543570**  
Dean  
S/S, Dentata  
Doppia Curva, Angolata  
mm170

# FORBICI PER SUTURE



**544110**  
Spencer  
S/B  
Retta  
mm90

**544280**  
Spencer  
S/B  
45°  
mm115

**544310**  
Spencer  
S/B  
Retta  
mm130

# FORBICI

## FORBICI PER GARZE



**545280**

Lister

S/B

45°

mm110

**545480**

Lister

S/B

45°

mm140

**545780**

Lister

S/B

45°

mm180

**546210**

ANELLO  
QUADRO

S/S

Retta

mm115

**546240**

ANELLO  
QUADRO

S/S

Curva

mm115

**546310**

ANELLO  
QUADRO

S/S

Retta

mm120

**546340**

ANELLO  
QUADRO

S/S

Curva

mm120

**546410**

ANELLO  
QUADRO

S/S

Retta

mm140

**546440**

ANELLO  
QUADRO

S/S

Curva

mm140

# FORBICI – MICRO CHIRURGIA



**548210**  
Noyes  
S/S  
Retta  
mm110



**548240**  
Noyes  
S/S  
Curva  
mm110



**548440**  
Castroviejo  
S/S  
Curva  
mm150



**549510**  
S/S  
Retta  
mm150



**549540**  
S/S  
Curva  
mm150

# DIVARICATORI – APRIBOCCA



**560020**

DIVARICATORE MOLT  
PICCOLO

Silicone Autoclavabile  
mm110

**560025**

GOMMINI RICAMBIO  
(2 PZ) PICCOLO



**560030**

DIVARICATORE MOLT  
MEDIO

Silicone Autoclavabile  
mm140

**560035**

GOMMINI RICAMBIO  
(2 PZ) MEDIO

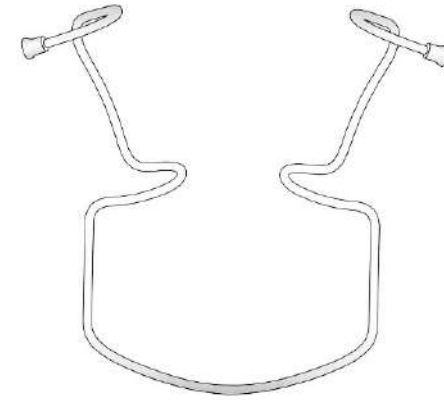

**560060**

ORINGER PICCOLO

Divaricatore per  
guance

Piccolo

mm40\*105

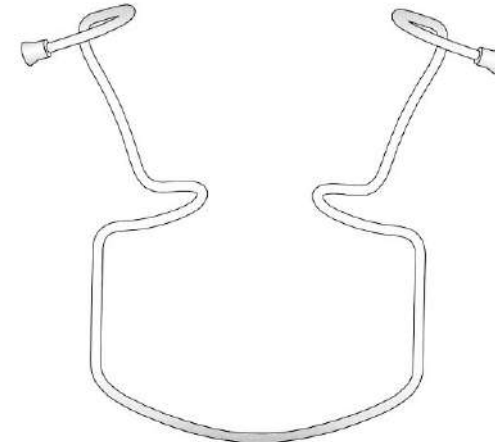

**560065**

ORINGER Medio

Divaricatore per  
guance

Medio

mm50\*110

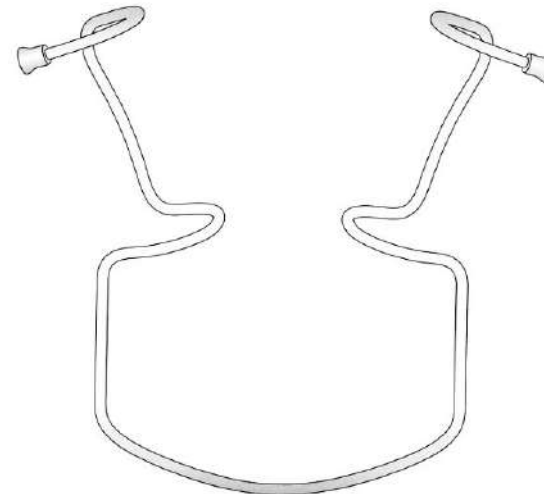

**560070**

ORINGER LARGE

Divaricatore per  
guance

Grande

mm60\*115

# DIVARICATORI – Obwegeser Interno

La punta rivolta verso il basso permette un maggior controllo della tenuta e nel contempo lascia maggior visuale per l'intervento.

La forma scanalata e convessa della lama permette un migliore appoggio al labbro e rende meno traumatica la retractione.

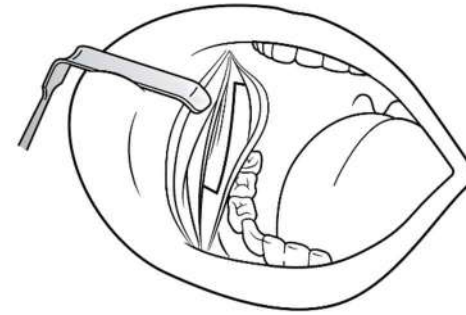

**560120**  
Interno  
mm210  
\*25\*7



**560130**  
Interno  
mm210  
\*35\*10



**560140**  
Interno  
mm210  
\*42\*10



**560150**  
Interno  
mm210  
\*55\*12



**560160**  
Interno  
mm210  
\*70\*14



**560170**  
Interno  
mm210  
\*80\*16

# DIVARICATORI – Obwegeser Esterno

La punta rivolta verso l'alto rende l'utilizzo del divaricatore meno traumatico per i tessuti molli.

La forma scanalata e convessa della lama, permette un miglior appoggio del labbro e rende meno traumatica la retrazione.

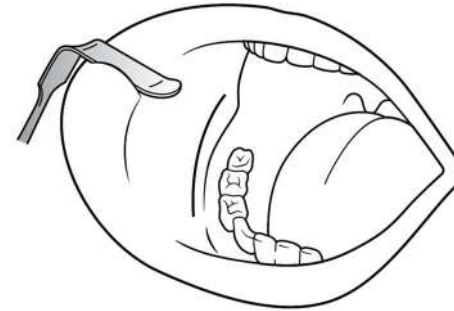

**560125**  
Esterno  
mm210  
\*25\*7



**560135**  
Esterno  
mm210  
\*35\*10



**560145**  
Esterno  
mm210  
\*42\*10



**560155**  
Esterno  
mm210  
\*55\*12



**560165**  
Esterno  
mm210  
\*70\*14



**560175**  
Esterno  
mm210  
\*80\*16

# DIVARICATORI

## LANGENBECK

---



**560180**  
Kocher

mm215  
40\*11

**560185**  
Kocher

mm215  
40\*11

**560210**

mm215  
30\*10

**560220**

mm215  
40\*10

**560230**

mm215  
40\*13

**560240**

mm215  
50\*10

**560250**

mm215  
50\*13



# DIVARICATORI

## MIDDELDORPF

---



**560310**  
Piccolo

mm190  
14\*17



**560320**  
Medio

mm190  
20\*22



**560330**  
Grande

mm190  
26\*30



**560370**  
Obwegeser-Ramus

mm215  
35\*11



**560390**  
Orientabile

mm200

# DIVARICATORI



**560550**  
DIVARICATORE  
Divaricatore  
per Mento  
mm150\*22\*8



**560560**  
STERNBERG  
Divaricatore  
per Guance  
mm140



**560565**  
STERNBERG  
Divaricatore  
per Guance  
mm160



**560570**  
STERNBERG  
Divaricatore per  
Guance  
mm140

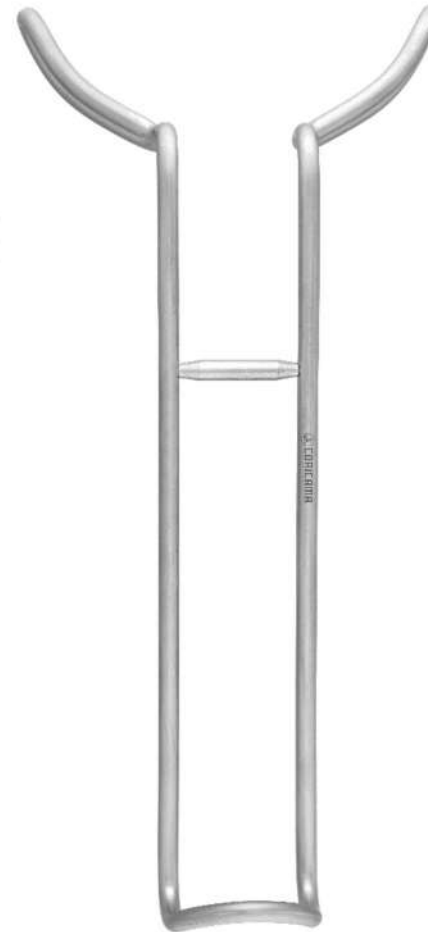

**560580**  
UNIVERSALE  
mm170



**560590**  
VESTIBULUM  
mm150

# DIVARICATORI



**560610**

Doppio

mm115\*35/45



**560620**

FARABEUF

Confezione da 2pz  
mm120\*30/35\*10/13



**560630**

Doppio

mm130\*50\*15



**560640**

Doppio

mm150\*50/70\*12



**560650**

MINNESOTA  
UNIVERSITY

mm140



**560660**

BRUENINGS

Abbassa Lingua  
mm190

# DIVARICATORI



**560810**  
DESMARRES

15\*10  
mm160



**560820**  
SENN-MILLER

3 punte  
mm160



**560860**  
APPUNTITO

3 punte  
mm165



**560870**  
ARROTONDATO

3 punte  
mm165



**560880**  
GILLIES  
APPUNTITO

Medio  
mm165



**560890**  
GILLIES  
APPUNTITO

Piccolo  
mm180



**560895**  
GILLIES  
APPUNTITO

Medio  
mm180

# DIVARICATORI



**561610**  
HENAHAN

mm170\*10



**561620**  
HENAHAN

mm170\*12



**561630**  
HENAHAN

mm170\*16



**561640**

mm170\*25



**561650**  
MISCH  
N.1

mm165



**561660**  
MISCH  
N.2

mm165



**561670**  
MISCH  
N.3

mm170

# DIVARICATORI

Bordi smussati e arrotondati per evitare di infierire sulla gengiva e minimizzare il disagio per il paziente.

Per consentire la massima visualizzazione di tutti i denti e le creste alveolari, retrainere e tirare le guance e le labbra del paziente lateralmente e allontanarle (leggermente in avanti) dai denti e dalla gengiva.

La forma speciale dei retrattori e degli espansori fotografici permettono che le guance e le labbra si ripieghino verso l'esterno.

Bagnare i retrattori poco prima dell'inserimento facilita il processo di posizionamento con un disagio minimo per il paziente.



**561910**  
DIVARICATORE ESPANSORE  
GUANCE/LABBRA



**561920**  
DIVARICATORE ESPANSORE  
GUANCE/LABBRA PEDIATRICO



**561930**  
DIVARICATORE  
FORMA - V



**561940**  
DIVARICATORE  
FORMA - C

# ASPIRATORI

Con bordi arrotondati e foro di depressione.



**562210**

CANNULA  
ASPIRAZIONE  
mm1,5

1,5\*175

**562230**

CANNULA  
ASPIRAZIONE  
mm3,0

3,0\*175

**562240**

CANNULA  
ASPIRAZIONE  
mm4,0

4,0\*175

**562250**

CANNULA  
ASPIRAZIONE  
mm5,0

5,0\*175

**562310**

ASPIRATORE  
CHIRURGICO  
mm2,5

2,5\*165

**562320**

ASPIRATORE  
CHIRURGICO  
mm3,0

3,0\*165

**562330**

ASPIRATORE  
CHIRURGICO  
mm4,0

4,0\*165

**562420**

FRAZIER  
mm2,0

2,0\*190

**562430**

FRAZIER  
mm3,0

3,0\*190

**562440**

FRAZIER  
mm4,0

4,0\*190

# PINZETTE

## Taylor

## Gerald

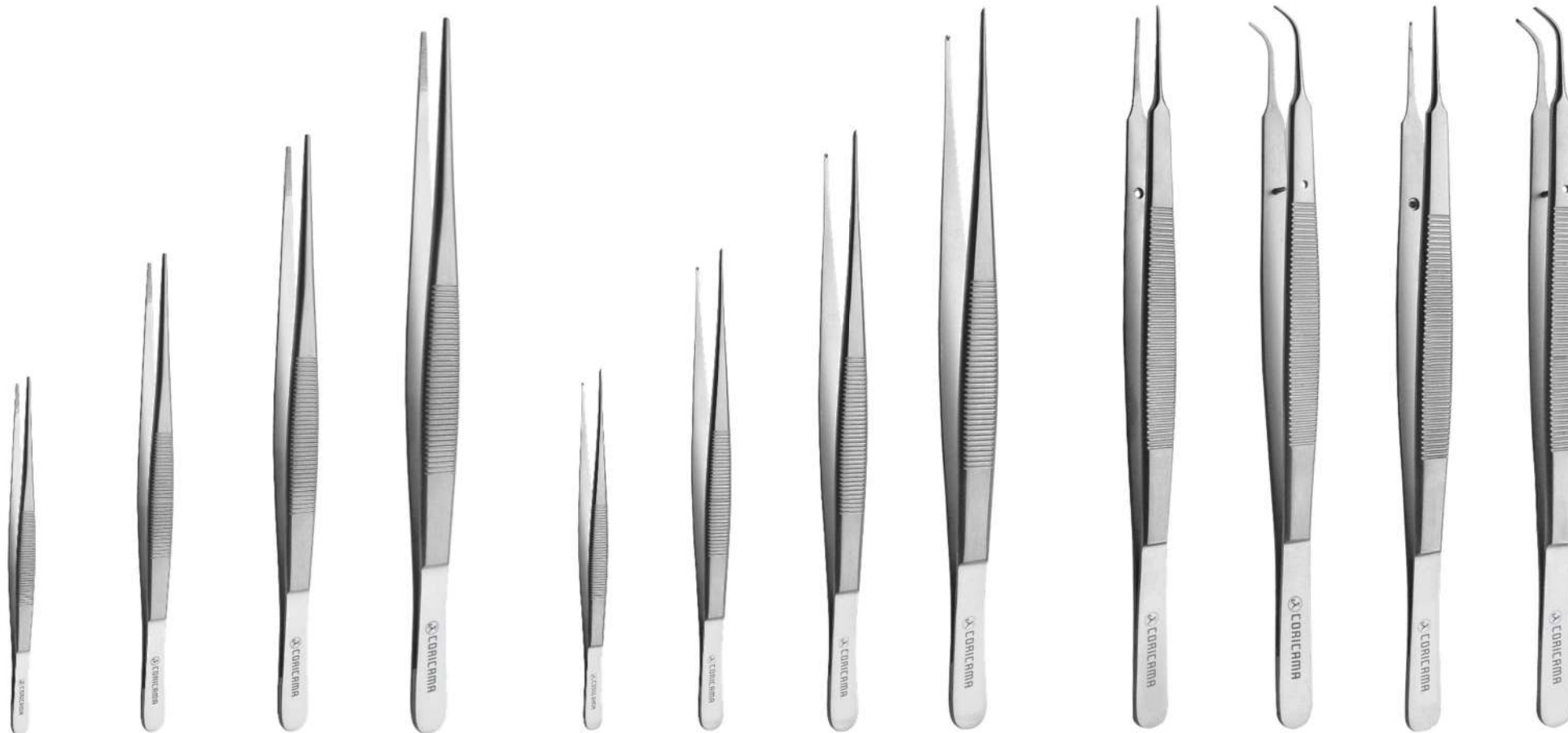

<b>563120</b>	<b>563130</b>	<b>563160</b>	<b>563190</b>	<b>563220</b>	<b>563230</b>	<b>563260</b>	<b>563290</b>	<b>563360</b>	<b>563365</b>	<b>563380</b>	<b>563385</b>
Zigrinata	Zigrinata	Zigrinata	Zigrinata	Liscia, 1x2	Liscia, 1x2	Liscia, 1x2	Liscia, 1x2	Zigrinata	Zigrinata Curva	Liscia, 1x2	Liscia, 1x2 Curva
mm90	mm120	mm150	mm180	mm90	mm120	mm150	mm180	mm175	mm175	mm175*0,9	mm175*0,9



# PINZETTE



**564180**  
Arrotondato  
Zigrinata

mm175



**564185**  
Arrotondato  
Curva, Zigrinata

mm175



**564290**  
Arrotondato  
Liscia,  
1x2

mm175\*0,9



**564295**  
Arrotondato  
Curva, Liscia  
1x2

mm175\*  
0,9



**564390**  
Arrotondato  
Zigrinata

mm175\*  
0,9



**564395**  
Arrotondato  
Curva

mm175\*  
0,9

Diamantata

# PINZETTE

Adson



**565110**  
Micro  
Zigrinata

mm120



**565125**  
Micro  
Liscia,  
1x2

mm120\*  
0,6



**565135**  
Micro  
Liscia,  
1x2

mm120\*  
0,9



**565141**  
Zigrinata

TC - Inerti  
Carburo di  
Tungsteno  
mm120



**565146**  
Micro  
Zigrinata, 1x2

TC - Inerti  
Carburo di  
Tungsteno  
mm120\*  
0,9



**565151**  
Brown  
Zigrinata,  
Scanalata

TC - Inerti  
Carburo di  
Tungsteno  
mm120



**565160**  
Zigrinata

mm150



**565165**  
Liscia,  
1x2

mm150\*  
0,9

# PINZETTE



**566260**  
DE BAKEY

Atrauma,  
Scanalata

mm150\*1,5

**566265**  
DE BAKEY

Angolata  
Atrauma,  
Curva,  
Scanalato

mm150\*1,5

**566160**  
PER SUTURE

Retta,  
Arrotondata,  
Perforata

mm155

**566165**  
PER SUTURE

Curva,  
Quadrata,  
Perforata

mm155

**566365**  
DE BAKEY  
MINI

Atrauma,  
Scanalata

mm155\*1,0

**566465**  
DE BAKEY  
MINI Angolata  
Atrauma,  
Curva,  
Scanalata

mm155\*1,0

**566470**  
COOLEY  
MICRO

Retta,  
Zigrinata,  
Scanalata

mm160

**566475**  
COOLEY  
MICRO

Curva,  
Zigrinata,  
Scanalata

mm160

# PINZETTE – MICRO-CHIRURGIA



**567330**  
PINZETTE  
PUNTE SOTTILI  
Retta, Liscia

mm125



**567360**  
PINZETTE  
PUNTE SOTTILI  
Angolata, Liscia

mm115



**567370**  
PINZETTE  
PUNTE SOTTILI  
Curva, Liscia

mm115



**567620**  
PINZETTE  
BISHOP-HARMAN  
Retta, Zigrinata

mm90



**567625**  
PINZETTE  
BISHOP-HARMAN  
Retta, Zigrinata

1x2  
mm90

# PINZE – EMOSTATICHE

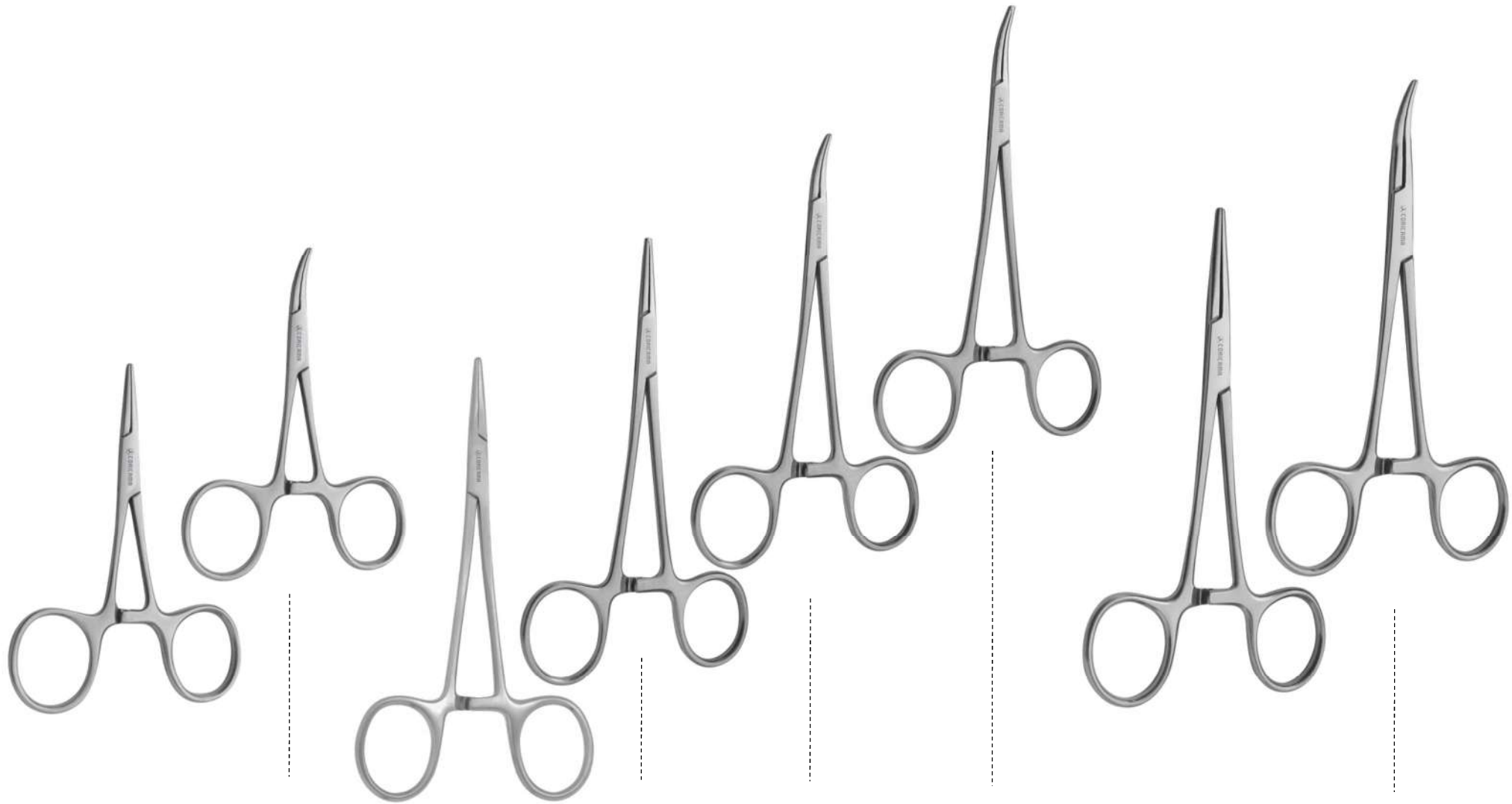

**568110**

HARTMANN  
Baby Mosquito  
Retta,  
Zigrinata  
mm90

**568115**

HARTMANN  
Baby Mosquito  
Curva,  
Zigrinata  
mm90

**568310**

HALSTEAD-  
MOSQUITO  
Retta,  
Zigrinata  
mm125

**568320**

HALSTEAD-  
MOSQUITO  
Retta,  
Zigrinata, 1x2  
mm125

**568330**

HALSTEAD-  
MOSQUITO  
Curva,  
Zigrinata  
mm125

**568340**

HALSTEAD-  
MOSQUITO  
Curva,  
Zigrinata, 1x2  
Mm125

**568370**

KELLY  
Retta,  
Zigrinata  
mm140

**568380**

KELLY  
Curva,  
Zigrinata  
mm140

# PINZE – EMOSTATICHE

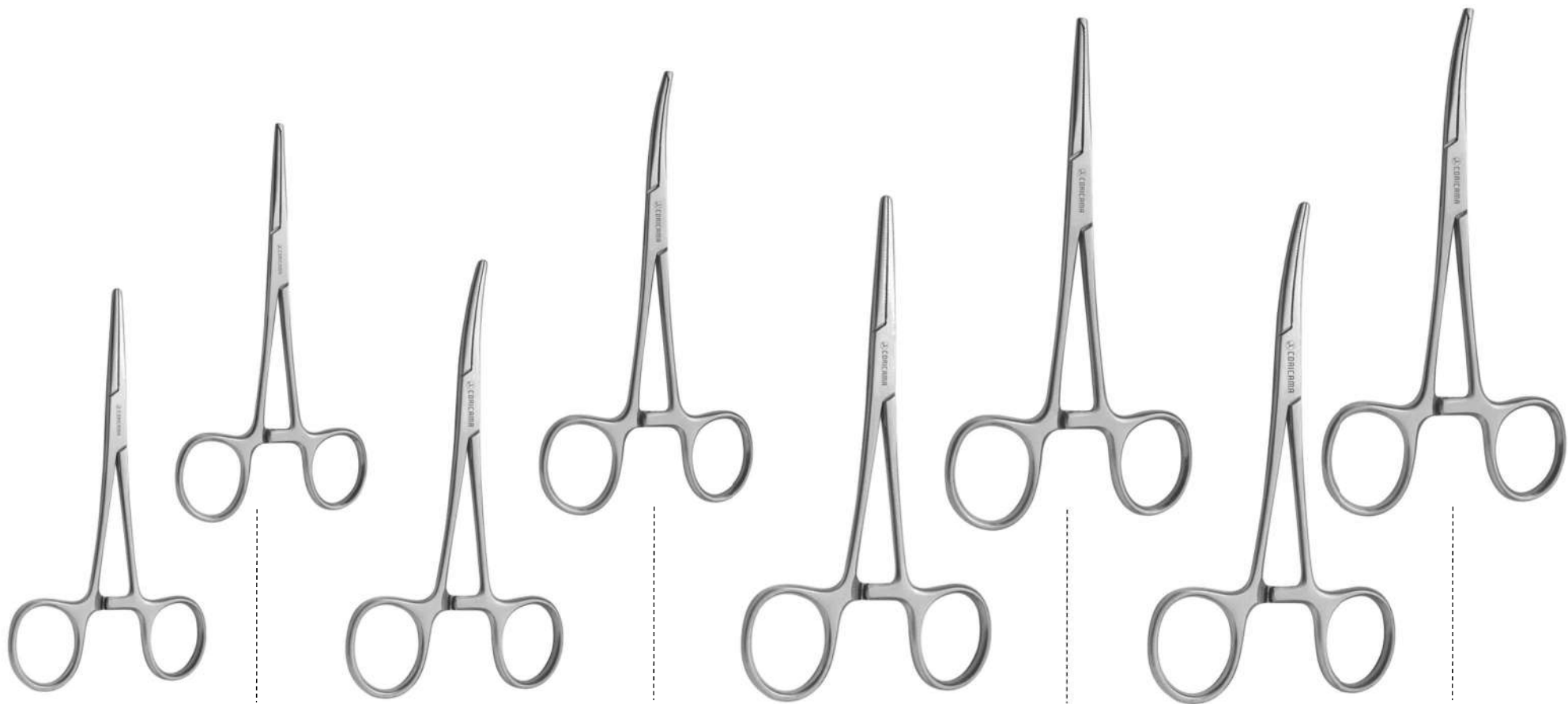

**568410**  
Rochester-Péan  
Retta,  
Zigrinata  
mm140

**568420**  
Rochester-Kocher  
Retta,  
Zigrinata, 1x2  
mm140

**568430**  
Rochester-Péan  
Curva,  
Zigrinata  
mm140

**568440**  
Rochester-Kocher  
Curva,  
Zigrinata, 1x2  
mm140

**568510**  
Rochester-Péan  
Retta,  
Zigrinata  
mm160

**568520**  
Rochester-Kocher  
Retta,  
Zigrinata, 1x2  
mm160

**568530**  
Rochester-Péan  
Curva,  
Zigrinata  
mm160

**568540**  
Rochester-Kocher  
Curva,  
Zigrinata, 1x2  
mm160

# PINZE – EMOSTATICHE



**568710**

Rochester-Péan  
Retta,  
Zigrinata  
mm180

**568720**

Rochester-Kocher  
Retta,  
Zigrinata, 1x2  
mm180

**568730**

Rochester-Péan  
Curva,  
Zigrinata  
mm180

**568740**

Rochester-Kocher  
Curva,  
Zigrinata, 1x2  
mm180

**568810**

Rochester-Péan  
Retta,  
Zigrinata  
mm200

**568820**

Rochester-Kocher  
Retta,  
Zigrinata, 1x2  
mm200

**568830**

Rochester-Péan  
Curva,  
Zigrinata  
mm200

**568840**

Rochester-Kocher  
Curva,  
Zigrinata, 1x2  
mm200

# PINZE PER MEDICAZIONE

## PINZE PER TESSUTI MOLLI

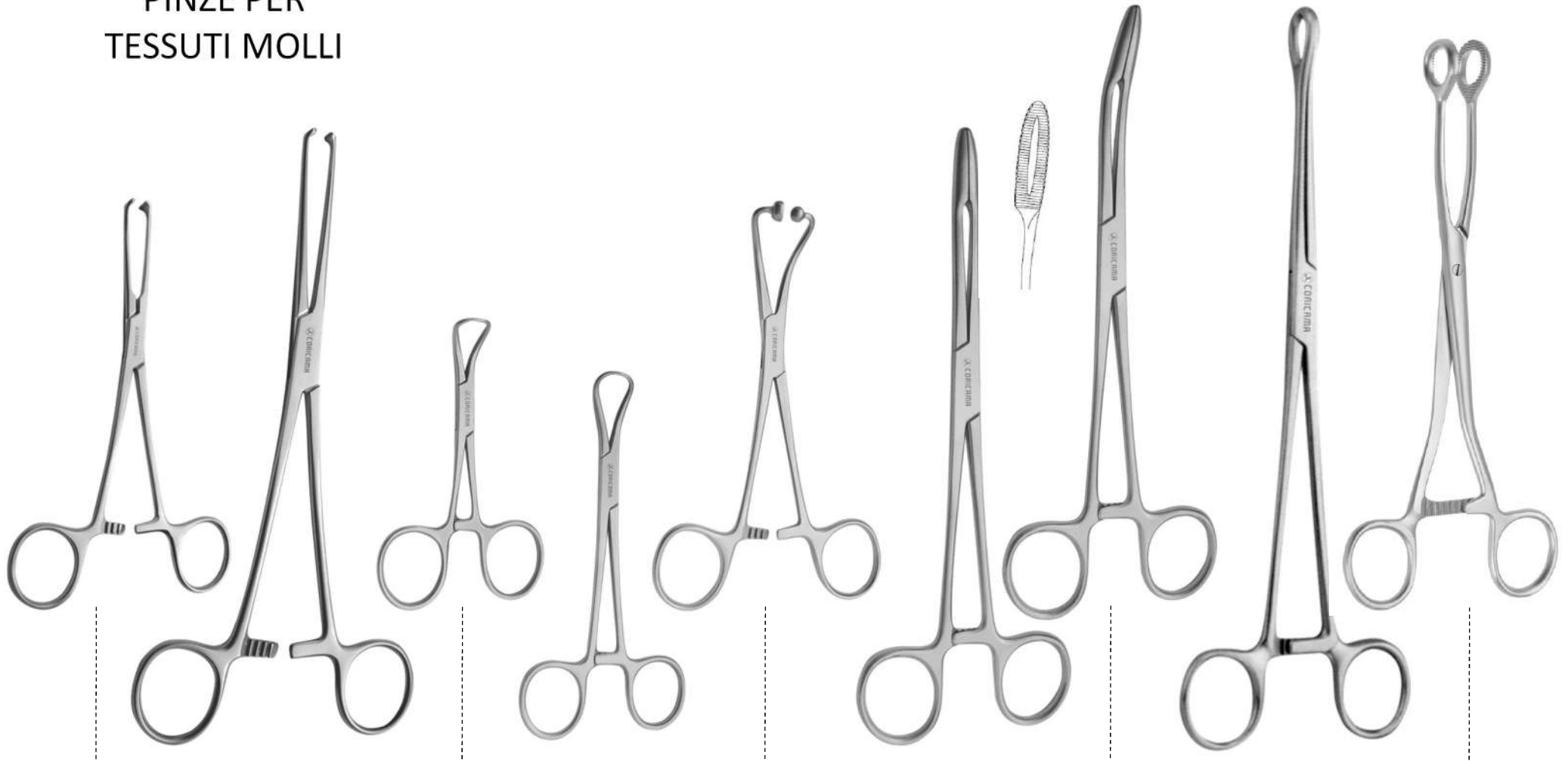

**569150**

Allis-Baby 3:4  
3Punte/4Punte  
Retta,  
Zigrinata

mm150

**569170**

Allis-Baby 4:5  
4Punte/5Punte  
Retta,  
Zigrinata

mm200

**569310**

Backhaus  
Curva,  
Appuntita

mm90

**569330**

Backhaus  
Curva,  
Appuntita

mm130

**569350**

Backhaus  
Curva,  
Arrotondata

mm140

**569440**

Gross Maier  
Retta,  
Zigrinata,  
Forata

mm200

**569460**

Gross Maier  
Curva,  
Zigrinata,  
Forata

mm200

**569680**

Foerster  
Retta,  
Zigrinata,  
Forata

mm250

**569940**

Collins  
Retta,  
Zigrinata,  
Forata

mm180



# SCOLLAPERIOSTEI



**571340**

HP3

mm5,2/4,8

**571360**

Molt

mm3,8/4,0

**571380**

Goldman-Fox  
N.14

mm4,5/5,5

**571520**

H02

mm7,0/5,0

**571540**

mm3,3/2,8

**571560**

Molt  
2-4

mm6,0/2,7

**571580**

Freer

mm4,0/4,0

**571590**

Freer

mm4,5/5,0

**571720**

Prichard

mm10,0/4,5

**571740**

mm8,0/8,0

# SCOLLAPERIOSTEI

CHIRURGIA 543



HOLLOW  
Ø 8mm

CORICAMA

<b>571760</b>	<b>571780</b>	<b>571940</b>	<b>571960</b>	<b>572530</b>	<b>572550</b>	<b>572580</b>	<b>572740</b>	<b>572760</b>	<b>572860</b>
24 G	Mead	Molt N.9	Allen	Hopkins N.1	Hopkins N.2	Bennet	Williger Appuntito	Williger Tondo	Seldin
mm4,0/4,0	mm7,0/7,0	mm4,0/7,0	mm3,5/8,0	mm175 2,5/3,2	mm175 3,5/4,0	mm175 4,5/2,8	mm155*6	mm155*7	mm195 12/10

# LIME PER OSSO



**574560**  
Miller N. 1  
Corta  
mm175



**574570**  
Miller N. 2  
Lunga  
mm175



**574580**  
Miller-Colburn N. 3  
Corta  
mm175



**574590**  
Miller-Colburn N. 4  
Lunga  
mm175



**574730**  
Miller N.1  
mm180



**574740**  
Miller N.2  
mm180



**574750**  
Miller N.3  
mm180

# PINZE OSSIVORE



**576220**  
Blumenthal  
mm155



**576240**  
Blumenthal  
Angolata 45°  
mm150



**576260**  
Blumenthal  
Angolata 90°  
mm140



**576320**  
Friedman  
mm140\*4



**576340**  
Friedman Micro  
mm145\*2



**576360**  
Friedman Micro  
Angolata 90°  
mm145\*2

# PINZE OSSIVORE



**576420**

Luer

mm150\*4



**576440**

Luer

Micro  
mm150\*3



**576460**

Lempert

Delicate  
mm160



**576520**

Beyer

mm155



**576540**

Cleveland

mm170

# CUCCHIAI ALVEOLARI

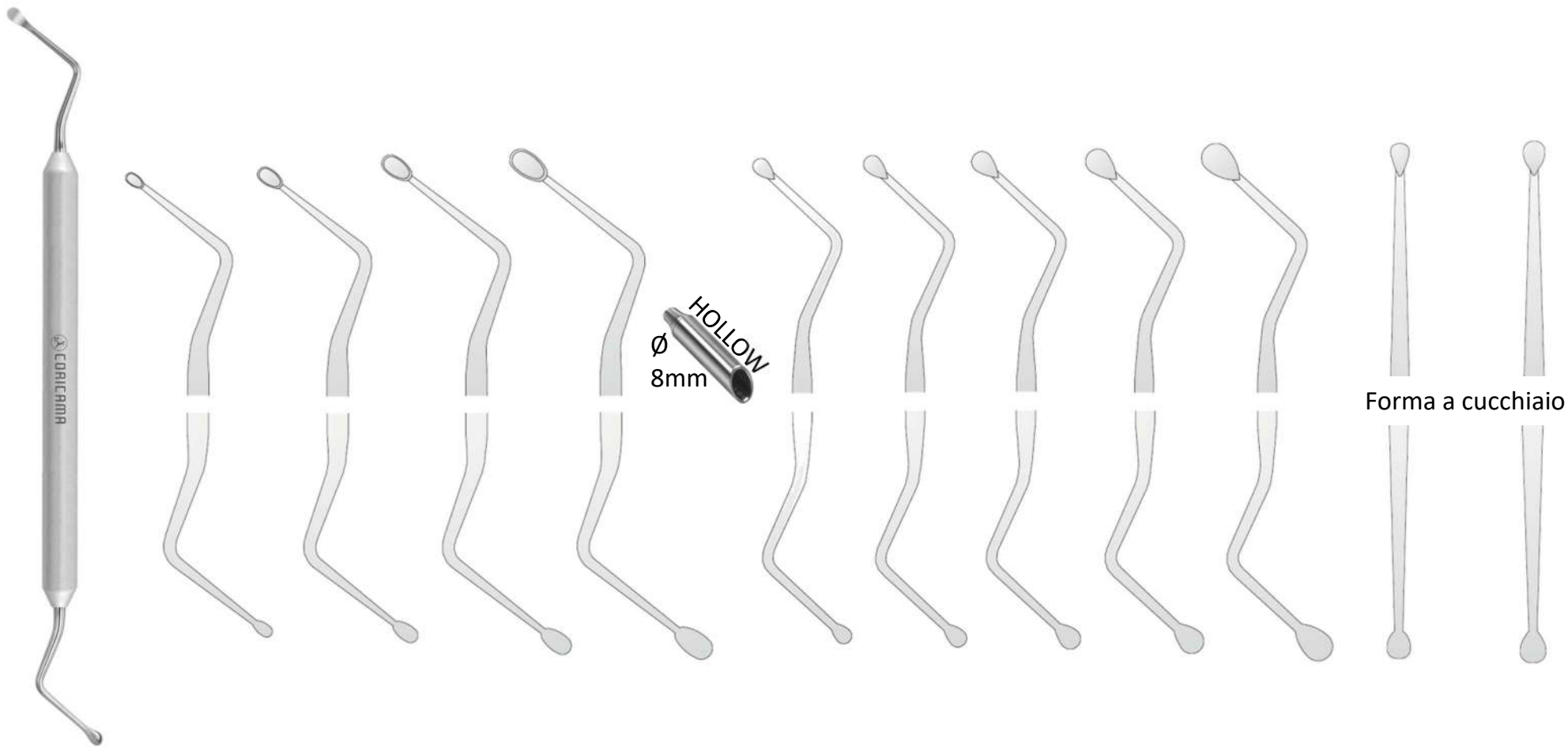

HOLLOW  
 Ø 8mm

Forma a cucchiaio

<b>581510</b>	<b>581520</b>	<b>581530</b>	<b>581540</b>	<b>581550</b>	<b>582510</b>	<b>582520</b>	<b>582530</b>	<b>582540</b>	<b>582550</b>	<b>582570</b>	<b>582580</b>
Hemingway	Hemingway	Hemingway	Hemingway	Hemingway	Lucas	Lucas	Lucas	Lucas	Lucas	Miller	Miller
N.0	N.1	N.2	N.3	N.4	N.84	N.85	N.86	N.87	N.88	N.0	N.1
mm2	mm2,5	mm3	mm3,5	mm4	mm2	mm2,5	mm3	mm3,5	mm4	mm3	mm4

# CUCCHIAI ALVEOLARI



**585835**  
Volkmann  
N.0  
mm170



**585840**  
Volkmann  
N.1  
mm170



**585845**  
Volkmann  
N.2  
mm170



**585850**  
Volkmann  
N.3  
mm170



**585860**  
Williger  
N.0  
mm150



**585870**  
Williger  
N.1  
mm150



**585880**  
Williger  
N.2  
mm150

# SIRINGHE – ASPIRANTI

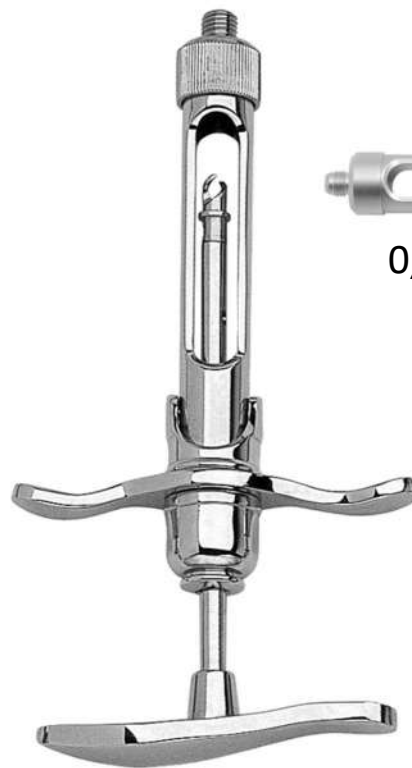

INTRALIGAMENTARE



0,2 ml/click

**591110**  
SIRINGA  
EU+AM  
Filettatura  
Europea +  
Americana  
  
Acciaio  
Inox  
1,8ml

**591150**  
SIRINGA  
EU+AM  
Filettatura  
Europea +  
Americana  
  
Acciaio  
Inox  
1,8ml

**591220**  
Cook-Waite  
EU  
Filettatura  
Europea  
  
Acciaio  
Inox  
1,8ml

**591225**  
Cook-Waite  
AM  
Filettatura  
Americana  
  
Acciaio  
Inox  
1,8ml

**591240**  
PIEGHEVOLE  
EU+AM  
Filettatura  
Europea +  
Americana  
  
Ottone  
cromato  
1,8ml

**591245**  
PIEGHEVOLE  
EU+AM  
Filettatura  
Europea +  
Americana  
  
Ottone  
cromato  
2,2ml

**591310**  
INTRALIGAMENTARE  
EU  
Filettatura  
Europea  
  
Acciaio  
Inox  
1,8ml

**591315**  
INTRALIGAMENTARE  
AM  
Filettatura  
Americana  
  
Acciaio  
Inox  
1,8ml





**CORICAMA**<sup>®</sup>  
since 1873

ESTRAZIONE

# Pinze Estrazione – Blade Beaks, SUPERIORI



**612210**  
N.1  
Incisivi e canini superiori



**612230**  
N.7  
Premolari superiori



**612250**  
N.17  
Molari superiori, destri



**612270**  
N.51  
Radici superiori



**612280**  
N.67  
Denti del giudizio superiori



**612220**  
N.34-N  
Incisivi centrali e canini superiori, punta strette



**612240**  
N.35-N  
Premolari superiori, punta strette



**612260**  
N.18  
Molari superiori, sinistri



**612275**  
N.51-AL  
Radici superiori



**612285**  
N.67-N  
Denti del giudizio superiori, punta strette

# Pinze Estrazione – Blade Beaks, INFERIORI



PINZE STANDARD

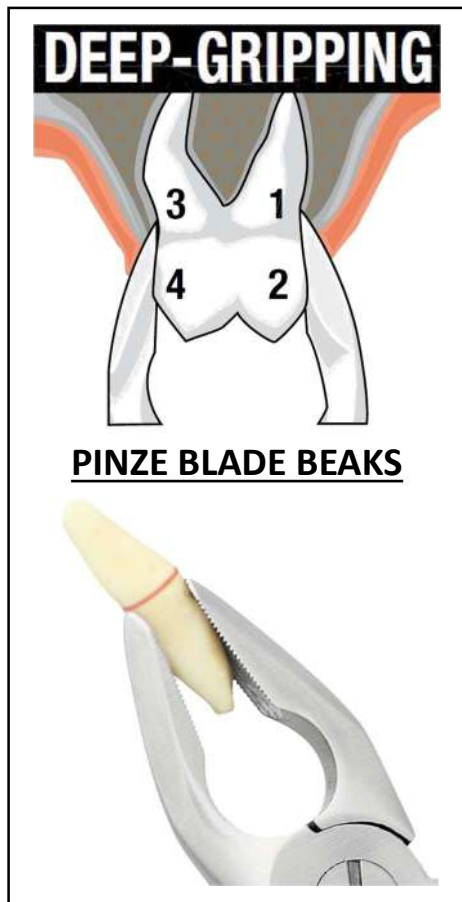

**612410**  
N.22  
Molari inferiori



**612430**  
N.74  
Radici inferiori e incisivi



**612450**  
N.79  
Denti del giudizio inferiori



**612440**  
N.13  
Premolari inferiori



**612460**  
N.187  
Frammenti di radici inferiori



**612455**  
N.79-N  
Denti del giudizio inferiori,  
punte strette



# Pinze Estrazione – Forma Inglese, SUPERIORI



**625110**

N.1

Incisivi centrali  
e canini superiori



**625120**

N.2

Incisivi laterali  
e canini superiori



**625130**

N.3

Incisivi  
e canini superiori



**625140**

N.107

Canini superiori



**625150**

N.180

Incisivi e canini  
Attacco profondo



**625170**

N.7

Premolari superiori



**625180**

N.136

Premolari, incisivi centrali  
e radici superiori



**625210**

N.17

Molari superiori destri



**625220**

N.18

Molari superiori sinistri



**625225**

N.18-A

Molari superiori

# Pinze Estrazione – Forma Inglese, SUPERIORI



**625230**

N.89

Molari superiori,  
destri



**625235**

N.90

Molari superiori,  
sinistri



**625250**

N.94

Molari superiori,  
destri



**625260**

N.95

Molari superiori,  
sinistri



**625270**

N.96

Molari superiori,  
destri



**625280**

N.97

Molari superiori,  
sinistri



**625310**

N.67

Denti del giudizio  
superiori



**625320**

N.67-A

Denti del giudizio  
superiori

# Pinze Estrazione – Forma Inglese, RADICI SUPERIORI



**625410**  
N.51  
Radici superiori



**625415**  
N.51-A  
Radici superiori



**625420**  
N.51-L  
Radici superiori



**625450**  
N.41  
Radici superiori



**625470**  
N.30  
Radici superiori



**625490**  
N.113  
Radici superiori



**625510**  
N.147  
Radici superiori



**625520**  
N.101  
Radici superiori



**625560**  
N.76  
Radici superiori



**625565**  
N.76-N  
Radici superiori  
punte strette

# Pinze Estrazione – Forma Inglese, INFERIORI



**625610**

N.4

Incisivi e canini inferiori



**625620**

N.75

Incisivi e premolari inferiori



**625630**

N.137

Incisivi inferiori e radici



**625640**

N.122

Incisivi inferiori e radici



**625650**

N.182

Incisivi, canini e premolari inferiori



**625660**

N.13

Premolari inferiori



**625670**

N.8

Premolari inferiori



**625710**

N.73

Molari inferiori



**625730**

N.73-L

Molari inferiori



**625750**

N.22

Molari inferiori



ESTRAZIONE 606

CORICAMA  
MADE IN ITALY

# Pinze Estrazione – Forma Inglese, INFERIORI



**625810**  
ROUTURIER SINISTRA  
Molari inferiori e dente del giudizio sinistro

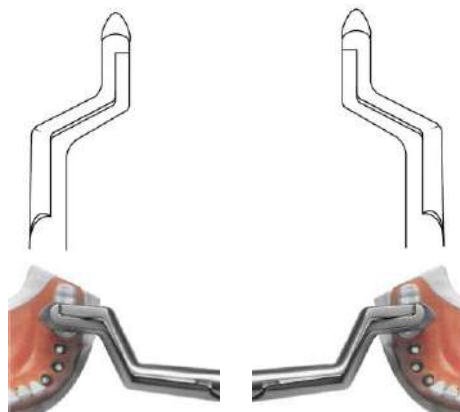

**625815**  
ROUTURIER DESTRA  
Molari inferiori e dente del giudizio destro



**625830**  
N.79  
Denti del giudizio



**625835**  
N.79-A  
Denti del giudizio



**625850**  
MANICO A FORBICE  
Denti del giudizio

COW HORN



**625860**  
N.86  
Molari inferiori scoronati



**625865**  
N.86-C  
Molari inferiori scoronati



**625870**  
N.91  
Per separare molari inferiori



**625880**  
N.99  
Molari inferiori



**625890**  
N.87  
Molari inferiori scoronati



# Pinze Estrazione – Forma Inglese, RADICI INFERIORI



**625910**  
N.33  
Radici Inferiori



**625915**  
N.33-A  
Radici inferiori



**625920**  
N.33-L  
Radici inferiori



**625930**  
N.74  
Radici inferiori  
e Incisivi



**625945**  
N.74-N  
Radici inferiori  
e Incisivi



**625980**  
N.185  
Radici inferiori



**625965**  
N.46  
Radici inferiori



# Pinze Estrazione – Forma Inglese, FRAMMENTI RADICI



**626150**  
PINZA STIEGLITZ  
mm150  
Pinza per frammenti



**626155**  
PINZA STIEGLITZ  
mm150 Curva  
Pinza per frammenti



**626120**  
N.189  
Frammenti di radici  
superiori



**626130**  
N.190  
Frammenti di radici  
superiori



**626140**  
N.187  
Frammenti di radici  
inferiori



**626160**  
WITZEL  
Universale per radici  
superiori



**626170**  
WITZEL  
Universale per radici  
inferiori

# Pinze Estrazione – Forma Americana, SUPERIORI



**632120**

N.150

Cryer

Incisivi, premolari e radici superiori, universale



**632140**

N.99-C

Premolari, canini e incisivi superiori



**632150**

N.32

Parmly

Molari, premolari e radici superiori, punte larghe



**632160**

N.18-R

Harris

Molari superiori destri



**632165**

N.18-L

Harris

Molari superiori sinistri



**632180**

N.53-R

Molari superiori, destri



**632185**

N.53-L

Molari superiori, sinistri



**632310**

N.88-R

Nevius

Molari superiori, destri



**632315**

N.88-L

Nevius

Molari superiori, sinistri



**632330**

N.210

Denti del giudizio



ESTRAZIONE 610

# Pinze Estrazione – Forma Americana, RADICI SUPERIORI e INFERIORI



**632340**

N.69

Tomes

Frammenti di radici,  
superiori e inferiori



**632350**

N.286

Radici, premolari  
e incisivi superiori



**632360**

N.65

Radici e frammenti  
superiori



**632580**

N.151

Cryer

Premolari, incisivi e radici  
inferiori, universale



**632720**

N.17

Molari inferiori



**632740**

N.16

Harris

Molari inferiori,  
CORNO di bue



**632750**

N.23

Molari inferiori,  
CORNO di bue



**632770**

N.222

Denti del giudizio

# Pinze Estrazione PEDIATRICHE – Forma Inglese CON MOLLA



**644210**  
CON MOLLA  
N.101  
Incisivi superiori



**644220**  
CON MOLLA  
N.111  
Premolari superiori



**644230**  
CON MOLLA  
N.115  
Molari superiori



**644240**  
CON MOLLA  
N.122  
Radici superiori



**644250**  
CON MOLLA  
N.160  
Molari inferiori e premolari



**644260**  
CON MOLLA  
N.150  
Incisivi inferiori e canini



**644270**  
CON MOLLA  
N.170  
Radici inferiori

# Pinze Estrazione PEDIATRICHE –Forma Inglese, SUPERIORI



**644320**  
N.163  
Superiori centrali



**644330**  
N.37  
Incisivi superiori



**644340**  
N.29-S  
Radici superiori



**644350**  
N.159  
Premolari superiori



**644370**  
N.158  
Premolari e molari superiori



**644380**  
N.39  
Molari superiori



**644390**  
N.39-R  
Molari superiori destri



**644395**  
N.39-L  
Molari superiori sinistri

# Pinze Estrazione PEDIATRICHE – Forma Inglese, INFERIORI



**644410**  
N.38  
Incisivi inferiori  
e canini



**644420**  
N.162  
Radici e incisivi  
inferiori



**644430**  
N.123  
Inferiori e radici



**644435**  
N.13-S  
Premolari inferiori



**644440**  
N.22-S  
Universale per  
radici inferiori



**644450**  
N.160  
Molari inferiori



# Pinze Estrazione PEDIATRICHE – Forma Americana



**647110**  
N.65

Incisivi e radici superiori



**647120**  
N.150

Cryer  
Premolari, incisivi, e radici superiori, universale



**647130**  
N.18-R

Harris  
Molari superiori destri



**647135**  
N.18-L

Harris  
Molari superiori sinistri



**647210**  
N.151

Cryer  
Premolari inferiori, incisivi, radici inferiori, universale



**647230**  
N.16

Harris  
Molari inferiori, CORNO di bue



**647250**  
N.69

Tomes  
Frammenti superiori e inferiori



**648150**  
PINZETTA  
ALBRECHT





# LEVE PER RADICI – APEXO



**662110**  
Apexo  
mm2,5x9

**662120**  
Apexo  
mm2,5x9 Curva

**662130**  
Apexo  
mm2,7x9

**662150**  
Apexo  
mm3x9

**662160**  
Apexo  
mm3x9 Curva

**662170**  
Apexo  
mm3x14

**662100**  
SET  
LEVE PER RADICI  
APEXO

Lama estremamente sottile, piatta e tagliente che permette una penetrazione che raggiunge la parte apicale delle radici ed un taglio preciso del ligamento periodontale.

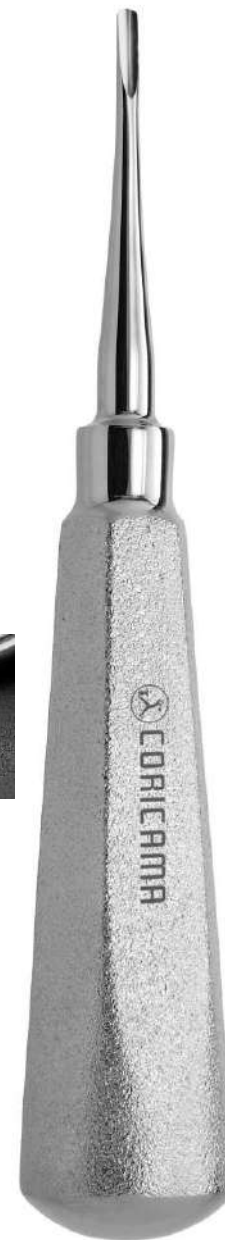

# LEVE PER RADICI – LUSSATORE



**662310**  
Lussatore  
mm3



**662320**  
Lussatore  
mm3 Curva



**662330**  
Lussatore  
mm4



**662340**  
Lussatore  
mm4 Curva



**662350**  
Lussatore  
mm5



**662360**  
Lussatore  
mm5 Curva

Lama estremamente piatta e tagliente, permette una precisa penetrazione e taglio del ligamento periodontale.  
L'uso delle leve Lussatore riduce i traumi esercitati sui denti e gengive ed in molti casi vanifica la necessità dell'uso delle tenaglie per estrazione.

**662300**  
SET  
LEVE PER RADICI  
LUSSATORE

# LEVE PER RADICI – LINDO LEVIAN



**662610**

Lindo Levian  
mm2,5x5

**662620**

Lindo Levian  
mm2,5x5 Curva

**662630**

Lindo Levian  
mm3x8

**662640**

Lindo Levian  
mm3x8 Curva

**662650**

Lindo Levian  
mm4x8

**662660**

Lindo Levian  
mm4x8 Curva

**662600**

SET  
LEVE PER RADICI  
LINDO LEVIAN

Le punte zigriate delle leve LINDO LEVIAN permettono l'estrazione della radice escludendo il classico effetto leva. Una volta inserita la punta in posizione, per mezzo di un delicato movimento rotatorio si potrà estrarre la radice.



# LEVE PER RADICI – BEIN



**664110**  
Tonda  
mm2



**664120**  
Tonda  
mm3



**664130**  
Tonda  
mm4



**664140**  
Piatta  
mm2



**664150**  
Piatta  
mm3



**664160**  
Piatta  
mm4



**664220**  
Sinistra  
mm3



**664230**  
Destra  
mm3



**664350**  
Mesiale  
mm2

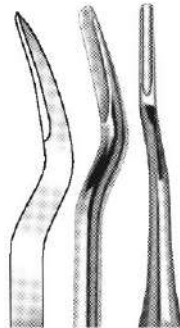

**664360**  
Distale  
mm2



**664370**  
Mesiale  
mm3



**664380**  
Distale  
mm3

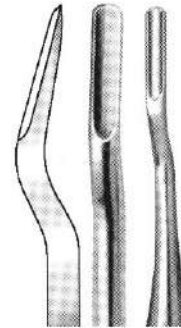

**664390**  
Mesiale  
mm4



**664395**  
Distale  
mm4



**664510**  
mm3,5



**664520**  
mm4,5

# LEVE PER RADICI



**664530**  
FLOHR mm3  
Sinistra



**664540**  
FLOHR mm3  
Destra



**664550**  
FLOHR mm3  
Sinistra



**664560**  
FLOHR mm3  
Destra



**664570**  
CRYER  
Sinistra



**664580**  
CRYER  
Destra



**664810**  
KOPP mm3,6  
Radici  
superiori



**664820**  
KOPP mm3,6  
Radici  
superiori



**664830**  
KOPP mm4,2  
Radici  
superiori



**664840**  
KOPP mm4,2  
Radici  
superiori



**664850**  
KOPP mm4,2  
Radici  
inferiori



**664860**  
KOPP mm4,2  
Radici  
inferiori

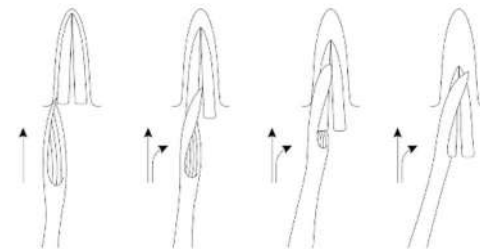

La zigrinatura interna e la forma elicoidale delle punte permette una facile penetrazione tra dente ed alveolo, ottenendo una estrazione sicura e veloce con una moderata pressione e rotazione della leva stessa.



# LEVE PER RADICI



**666110**  
Retta  
mm2



**666120**  
Retta  
mm2,5



**666130**  
Retta  
mm3



**666140**  
Retta  
mm3,5



**666150**  
Retta  
mm4



**666160**  
Retta  
mm4,5



**666360**  
Apical 302  
mm2,5  
Sinistra



**666365**  
Apical 303  
mm2,5  
Destra



**666370**  
Flohr  
mm3,0  
Sinistra



**666375**  
Flohr  
mm3,0  
Destra



**666320**  
Apical 301



**666325**  
Apical 304  
mm3,0



**666330**  
12 A  
mm3,0



**666335**  
Seldin 34 S  
mm4



**666340**  
Seldin  
mm5,2



**666345**  
mm3,2



**666350**  
Flohr  
mm4,2



**666355**  
Seldin  
mm3,5

# LEVE PER RADICI



**666520**  
Flohr  
mm3,2



**666525**  
Seldin  
Sinistra



**666530**  
Seldin  
Destra



**666545**  
Miller 1  
Sinistra



**666550**  
Miller 2  
Destra



**666555**  
Cryer  
Sinistra



**666560**  
Cryer  
Destra



**666565**  
Cryer  
Sinistra



**666570**  
Cryer  
Destra



**666710**  
Coupland  
mm3,0



**666720**  
Coupland  
mm3,6



**666730**  
Coupland  
mm4,2



**668110**  
Medan-  
Bein  
Appuntita  
mm2,5



**668120**  
Medan-  
Bein  
Piatta  
mm3,0



**668130**  
Medan-  
Bein  
Tonda  
mm3,0



**668140**  
Medan-  
Bein  
Tonda  
mm3,6



**668150**  
Medan-  
Flohr  
Sinistra



**668160**  
Medan-  
Flohr  
Destra



**668170**  
Medan-  
Cryer  
Sinistra



**668180**  
Medan-  
Cryer  
Destra



# LEVE PER RADICI



**668410**  
London  
Hospital  
Coleman  
mm5,0



**668430**  
London  
Hospital  
Coleman  
mm4,0  
Sinistra



**668440**  
London  
Hospital  
Coleman  
mm4,0  
Destra



**668450**  
Hylin  
mm3,0



**668460**  
Hylin  
mm4,5



**668470**  
Hylin  
PIATTA  
Molari e  
premolari



**668480**  
Hylin  
mm3,0  
Sinistra



**668490**  
Hylin  
mm3,0  
Destra

Manico  
a "T"



**668610**  
W.Barry  
Sinistra



**668615**  
W.Barry  
Destra



**668620**  
W.Barry  
Sinistra



**668625**  
W.Barry  
Destra



**668635**  
Winter  
Sinistra



**668640**  
Winter  
Destra



**668645**  
Winter  
Sinistra



**668650**  
Winter  
Destra



**668655**  
Winter  
Sinistra



**668660**  
Winter  
Destra



# LEVE PER RADICI – FRAMMENTI RADICOLARI e APICALI



**668810**  
mm2,2 PIATTO  
Warwick-James



**668820**  
mm2,2 PIATTO  
Warwick-James  
Sinistra



**668830**  
mm2,2 PIATTO  
Warwick-James  
Destra

Ø mm6



**671440**  
Heidbrink  
mm2,5



**671450**  
Heidbrink  
mm2,5  
Sinistra



**671460**  
Heidbrink  
mm2,5  
Destra



**671670**  
Heidbrink  
mm1,5



**671680**  
Howard  
mm2,5



**670610**  
Heidbrink



**670620**  
Heidbrink  
Sinistra



**670630**  
Heidbrink  
Destra

# SINDESMOTOMI



**681030**  
MANICO  
mm115



**681050**  
BASE PER PUNTE



<b>681110</b>	<b>681115</b>	<b>681120</b>	<b>681130</b>	<b>681135</b>	<b>681140</b>	<b>681145</b>	<b>681150</b>	<b>681155</b>	<b>681160</b>	<b>681165</b>
PUNTA	PUNTA	PUNTA	PUNTA	PUNTA	PUNTA	PUNTA	PUNTA	PUNTA	PUNTA	PUNTA
FIG.11	FIG.0	FIG.1	FIG.2	FIG.3	FIG.4	FIG.5	FIG.6	FIG.7	FIG.8	FIG.9
Retta	Retta	Curva	Sinistra	Destra	Destra	Sinistra	Sinistra	Destra	Bayonet Distal	Bayonet Mesial



**682310**  
Retta



**682320**  
Curva



**682510**  
Chompret  
N. 1



**682520**  
Chompret  
N. 2



**682530**  
Chompret  
N.3, Faucille



**682540**  
Chompret  
N.4, Faucille

**681000**  
SET  
SINDESMOTOMI





**CORICAMA**<sup>®</sup>  
since 1873

ORTODONZIA

# TRONCHESI Distali



**711821**

N.69

TC - Inerti Carburo  
Tungsteno

Per fili SS & NiTi

Ø max 0,3 mm

Mm125



**711921**

N.69 LUNGO

TC - Inerti Carburo  
Tungsteno

Per fili SS & NiTi

Ø max 0,3 mm

mm150

**701020**

KIT ORTODONZIA ADVANCED

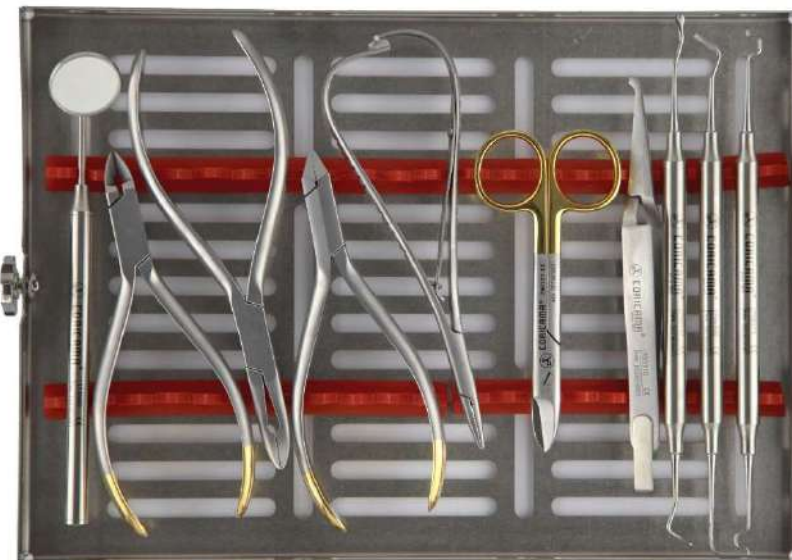

133502, 711821, 712421, 722220, 732131, 752520,  
756520, 756555, 756575, 760121, 783310, 911830

MANICO SPECCHIETTO MOD. LISCIO Ø 8mm +  
SPECCHIETTO N.5 PIANO - 1 pezzo, TRONCHESE DISTALE  
N.69 TC, TRONCHESE N.85 TC, PINZA WEINGART, PINZA  
ADAMS TC mm125, PORTA AGHI MATHIEU MINI,  
DIREZIONATORE PER LEGATURE TUCKER N.1, SPINGIBANDE  
- SCALER, APPLICATORE PER ELASTICI, FORBICE BEEBEE  
mm110 TC, PINZETTA PER BRACKETS CON LAMA, VASSOIO  
GAMMAFIX CINC ROSSO

I contenuti possono essere  
personalizzati su richiesta del cliente.

CORICAMA si riserva il diritto di modificare il contenuto  
dei suoi KIT in qualsiasi momento senza preavviso.

# TRONCHESI per Legature



**712021**

N.89

TC - Insetti Carburo  
Tungsteno

ø max 0,3 mm  
mm120



**712221**

N.91

TC - Insetti Carburo  
Tungsteno

ø max 0,3 mm  
mm125



**712421**

N.85

TC - Insetti Carburo  
Tungsteno

ø max 0,3 mm  
mm130



**712621**

N.85 – 15°

TC - Insetti Carburo  
Tungsteno

ø max 0,3 mm  
mm130



**712821**

N.99

TC - Insetti Carburo  
Tungsteno

ø max 0,5 mm  
mm130

# TRONCHESI per Fili Duri



**713421**

N.87

TC – Insetti Carburo  
Tungsteno

ø max 0,7 mm  
mm130



**713521**

N.87 – 15°

TC – Insetti Carburo  
Tungsteno

ø max 0,7 mm  
mm130



**714221**

N.18

TC – Insetti Carburo  
Tungsteno

ø max 1,0 mm  
mm155



**714421**

N.92

TC – Insetti Carburo  
Tungsteno

ø max 1,0 mm  
mm140

# PINZE Ausiliarie



**722220**  
WEINGART

∅ max 0,5 mm  
mm140

**722330**  
WEINGART FINE

∅ max 0,5 mm  
mm145

**722521**  
WEINGART ANGOLATA  
TC - Inerti Carburio  
Tungsteno

∅ max 0,5 mm  
mm140

**722720**  
HOW RETTA

∅ max 0,7 mm  
mm140

**722820**  
HOW CURVA

∅ max 0,7 mm  
mm140

# PINZE Piega Fili



**731421**  
Contorni  
TC – Inerti Carburio  
Tungsteno  
ø max 0,6 mm  
mm130



**732120**  
Adams  
ø max 0,4 mm  
mm125



**732131**  
Adams  
TC – Inerti Carburio  
Tungsteno  
ø max 0,4 mm  
mm125



**732141**  
N.64  
TC – Inerti Carburio  
Tungsteno  
ø max 0,7 mm  
mm140



**732160**  
Jarabak  
ø max 0,7 mm  
mm140



# PINZE Piega Fili



**732221**  
Angle N.138

TC - Inerti Carbuoro  
Tungsteno  
ø max 0,7 mm  
mm125



**732241**  
Angle N.139

TC - Inerti Carbuoro  
Tungsteno  
ø max 0,7 mm  
mm125



**732430**  
Bird beaks

ø max 0,7 mm  
mm130



**732630**  
Tonda punte  
corte

ø max 0,7 mm  
mm125



**732730**  
Tonda punte  
lunghe

ø max 0,6 mm  
mm140

# PINZE Piega Fili



**732530**

Delicate Beaks

∅ max 0,7 mm  
mm135



**734730**

Linguale

∅ max 0,7 mm  
mm125



**734830**

De La Rosa  
Scanalata

∅ max 0,5 mm  
mm125



**735130**

De La Rosa

∅ max 0,5 mm  
mm125



**735530**

Optical

∅ max 0,7 mm  
mm140

# PINZE Piega Fili



**735630**

Hollow chop

∅ max 0,8 mm  
mm140



**736130**

Tweed  
Corta

∅ max 0,5 mm  
mm130



**736330**

Tweed  
Corta, Zigrinata

∅ max 0,5 mm  
mm135



**736530**

Tweed - O'Brein

∅ max 0,7 mm  
mm140



**736630**

Young

∅ max 0,7 mm  
mm130

# PINZE Piega Fili



**740330**

Aderer  
Corta  
Ø max 0,6 mm  
mm120



**740430**

Aderer  
Lunga  
Ø max 0,7 mm  
mm130



**740630**

3 Prong  
Ø max 0,4 mm  
mm130



**740830**

Per Anse  
Ø max 0,5 mm  
mm140



**744230**

Tweed  
Corta  
Ø max 0,5 mm  
mm125



**744330**

Tweed  
Lunga  
Ø max 0,7 mm  
mm130

# PINZE Piega Fili

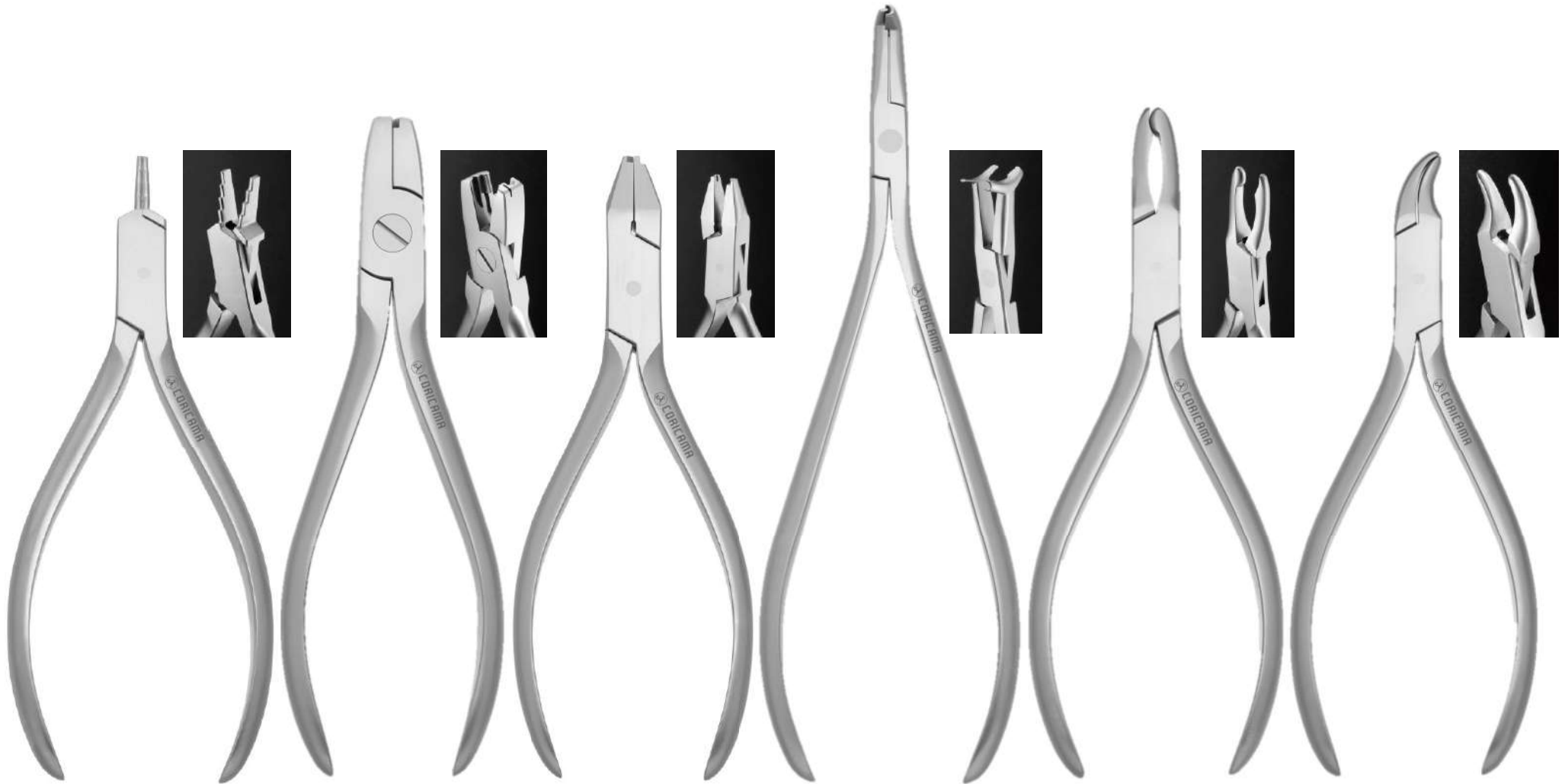

**745130**  
Nance

∅ max 0,7 mm  
mm130

**745530**  
Nance

∅ max 0,7 mm  
mm135

**745730**  
Crimpable  
archwire hook

∅ max 0,7 mm  
mm130

**745830**  
Cinch Back

∅ max 0,7 mm  
mm155

**746230**  
Johnson

mm135

**746330**  
Reynolds

mm130

# PINZE per Legature



**752120**  
Smaha  
Retta  
mm140



**752320**  
Smaha  
Curva  
mm140



**752520**  
Mathieu  
Mini  
mm140



**752720**  
Mathieu  
Mini – Lisce  
mm140



**752920**  
Mathieu  
Mini – Lisce  
Per moduli  
mm140

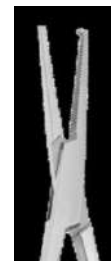

**753610**  
Per dentalastics  
mm120

# FORBICI per Fili e Corone



**760110**

High Performance  
S/B

Alta temperatura e  
precisione di taglio  
Retta  
mm90

**760115**

High Performance  
S/B

Alta temperatura e  
precisione di taglio  
Retta  
mm110

**760120**

Beebee  
S/S, Dentata

Retta  
mm110

**760130**

Beebee  
S/S, Dentata

Curva  
mm110

**760140**

Universale  
S/S, Dentata

Retta, Angolata  
mm125

**760141**

Universale  
S/S

TC - Inerti  
Carburo  
Tungsteno

Retta, Angolata  
mm125

# Strumenti per BANDE e BRACKETS



**746530**

Rimozione Bracket  
Retta  
mm135



**746630**

Rimozione Bracket  
Curva  
mm135



**746720**

Pinza Rimozione  
Bande Posteriori  
Corta  
mm135



**746822**

Gommini di  
ricambio, 2 pz  
autoclavabile



**746820**

Pinza Rimozione  
Bande Posteriori  
Lunga  
mm135



# Strumenti per BANDE e BRACKETS



**762350**  
SPINGIBANDE  
MERSHON

mm150



**762420**  
SPINGIBANDE  
MANICO TEFLON

mm145



**762510**  
POSIZIONATORE  
PER BANDE

mm140

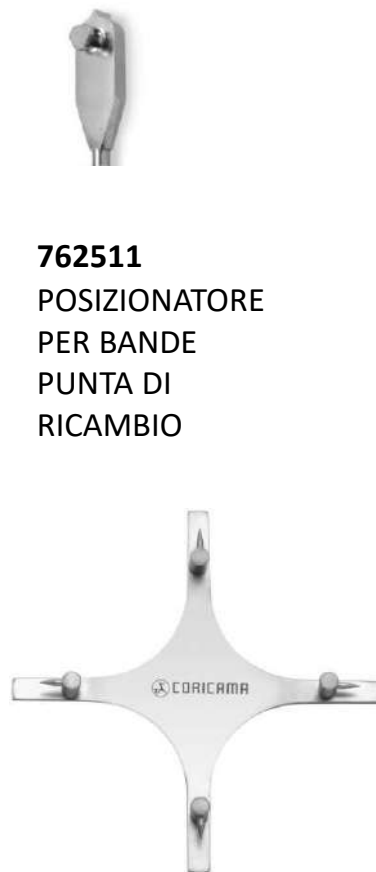

**762511**  
POSIZIONATORE  
PER BANDE  
PUNTA DI  
RICAMBIO

**772220**  
POSIZIONATORE  
PER BRACKET

mm65\*65

## ALTIMETRO PER BRACKET

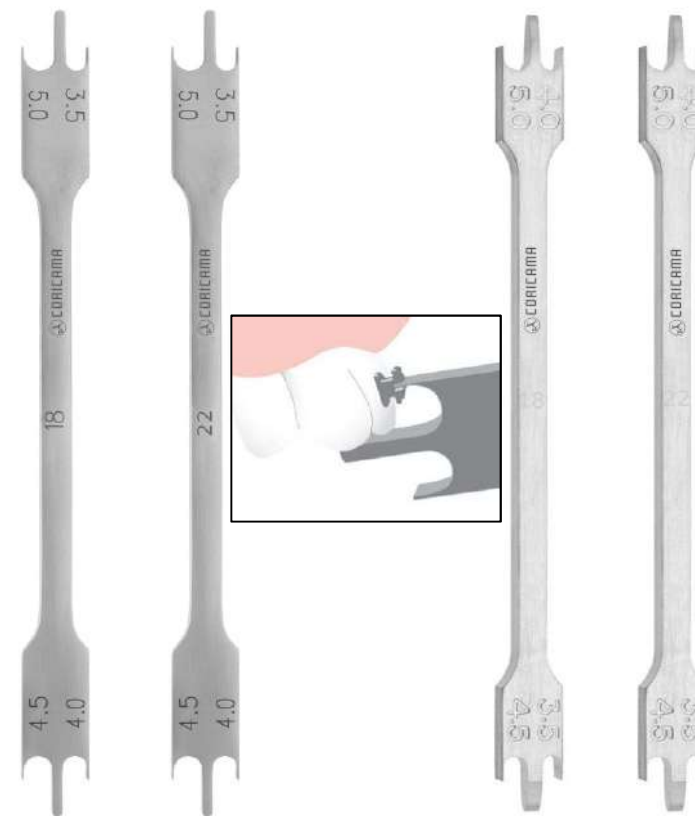

**772420** **772425**  
Per slot 018 Per slot 022

ACCIAIO INOX  
mm130 mm130

**772433** **772438**  
Per slot 018 Per slot 022

ALLUMINIO  
mm150 mm150

# Strumenti per BANDE e BRACKETS



**772940**

STRUMENTO PER  
PIEGA FILI DISTALE  
N.1

Dimensioni foro:  
ø mm 0,75 – 030"  
mm160

**772945**

STRUMENTO PER  
PIEGA FILI DISTALE  
N.2

Dimensioni foro:  
ø mm 0,75 – 030"  
mm160

**783310**

CON LAMA  
mm135

**783330**

mm140

**783340**

mm140

**783370**

mm140

**783380**

BUCALE  
mm140

PINZETTE PER POSIZIONAMENTO DEI BRACKETS

**315840**

PINZA PER  
ELASTICI  
mm150

# Strumenti per BANDE e LEGATURE



**756515**  
DIREZIONATORE  
PER LEGATURE  
N.0

**756520**  
DIREZIONATORE  
PER LEGATURE  
TUCKER N.1

**756530**  
DIREZIONATORE  
PER LEGATURE  
TUCKER N.2

**756535**  
DIREZIONATORE  
PER LEGATURE  
MINI

**756550**  
SPINGIBANDE  
SCALER MINI

**756555**  
SPINGIBANDE  
SCALER

**756570**  
SPINGIBANDE  
SCALER N.2C

**756575**  
APPLICATORE  
PER ELASTICI





**CORICAMA**<sup>®</sup>  
since 1873

PROTESICA

# Strumenti per MODELLARE – P.K. THOMAS



**813410**

P.K. THOMAS  
N.1

**813420**

P.K. THOMAS  
N.2

**813430**

P.K. THOMAS  
N.3

**813440**

P.K. THOMAS  
N.4

**813450**

P.K. THOMAS  
N.5

**813400**

SET P.K. THOMAS  
ACCIAIO INOX

SOLID  
Ø 6mm

# Strumenti per MODELLARE – P.K. THOMAS



**813704**  
SET P.K. THOMAS  
ALLUMINIO



<b>813714</b>	<b>813724</b>	<b>813734</b>	<b>813744</b>	<b>813754</b>
P.K. THOMAS	P.K. THOMAS	P.K. THOMAS	P.K. THOMAS	P.K. THOMAS
N.1	N.2	N.3	N.4	N.5
GIALLO	ROSSO	BLU	VERDE	ARGENTO

# Strumenti per MODELLARE

----- PROTESICA 803



**815230**  
LE CRON  
mm160



**815240**  
LE CRON  
mm160



**815250**  
MSY  
mm145



**815310**  
ZAHLE  
mm120



**815320**  
ZAHLE  
mm125



**815330**  
ZAHLE  
mm130



**815350**  
HYLIN  
mm135



**815380**  
GRITMAN  
mm180



# Strumenti per MODELLARE – SPATOLE PER CEMENTO



**826590**  
N.24



**826810**  
N.00  
mm4,0/2,5



**826820**  
N.0  
mm4,0/5,5



**826830**  
N.1  
mm5,5/5,5



**826840**  
N.2  
mm6,5/6,5



**826850**  
N.3  
mm7,5/7,5



**826860**  
N.4  
mm6,5/9,5



**826880**  
WESTON



**826890**  
FLESSIBILE

# Strumenti per MODELLARE – STRUMENTI PER CERAMICA

PROTESICA 805



**828700**  
SET STRUMENTI PER  
CERAMICA  
Alluminio

**828720**  
Alluminio,  
Giallo

**828740**  
Alluminio,  
Blu

**828760**  
Alluminio,  
Rosso

**828800**  
SET STRUMENTI PER  
CERAMICA  
DOUBLE-ENDED  
Alluminio

**828820**  
Alluminio,  
Giallo

**828840**  
Alluminio,  
Blu

**828860**  
Alluminio,  
Rosso



CORICAMA

# Strumenti per MODELLARE



**831330**  
PINZETTA PER CARTA  
ARTICOLAZIONE  
RETTA  
Miller  
mm155



**831340**  
PINZETTA PER CARTA  
ARTICOLAZIONE  
CURVA  
Miller  
mm155



**834725**  
PINZA UNIVERSALE  
Pinza multiuso.  
Per piegature fino a 0,9 mm.  
Per il taglio fino a 0,7 mm.  
mm155



**835100**  
ARTICOLATORE

**835200**  
OCCLUSORE



# Strumenti per MODELLARE – COLTELLI PER CERA



**820110**  
FAHNENSTOCK

mm125



**820120**  
FAHNENSTOCK

mm175



**820150**  
LESSMANN

mm125



**820160**  
LESSMANN

mm175



**820180**  
GRITMANN

mm170

# Strumenti per MODELLARE – SPATOLE PER CERA



**822120**  
ELASTOMERI  
RIGIDA  
mm190



**822130**  
ALGINATO  
CURVA  
mm200\*18



**822140**  
ALGINATO  
mm205\*18



**822150**  
ALGINATO  
mm215\*31



**822160**  
ALGINATO  
8X  
230\*21/28



**822170**  
ALGINATO  
mm180

# PORTA IMPRONTE – PERFORATE CON BORDINO RITENTIVO

## SUPERIORE

**841110**

XXS – U1  
mm56\*44



**841120**

XS – U2  
mm65\*52

**841130**

S – U3  
mm68\*54

**841140**

M – U4  
mm71\*58



**841150**

L – U5  
mm73\*59

**841160**

XL – U6  
mm78\*63

**841170**

Pediatrica

**841180**

DR  
PARZIALE  
DESTRA  
Superiore-Destra  
Inferiore-Sinistra



**841100**

KIT PORTA IMPRONTE  
CON BORDINO RITENTIVO  
Contiene 12 pz

**841190**

SL  
PARZIALE  
SINISTRA  
Superiore-Sinistra  
Inferiore-Destra

## INFERIORE

**841115**

XXS – L1  
mm56\*44

**841125**

XS – L2  
mm66\*50

**841135**

S – L3  
mm70\*52

**841145**

M – L4  
mm73\*56

**841155**

L – L5  
mm76\*58

**841165**

XL – L6  
mm78\*60

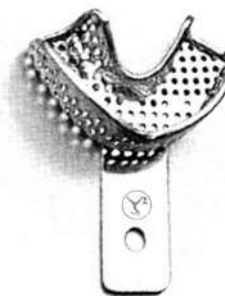

**841175**

Pediatrica

# PORTA IMPRONTE – PERFORATE CON BORDINO RITENTIVO

## SUPERIORE

**841310**  
XXS – U1  
mm56\*44



**841320**  
XS – U2  
mm65\*52

**841330**  
S – U3  
mm68\*54

**841340**  
M – U4  
mm71\*58

**841350**  
L – U5  
mm73\*59

**841360**  
XL – U6  
mm78\*63

**841300**  
KIT PORTA IMPRONTE  
SENZA BORDINO RITENTIVO  
Contiene 12 pz



**841380**  
DR  
PARZIALE DESTRA  
Superiore-Destra  
Inferiore-Sinistra

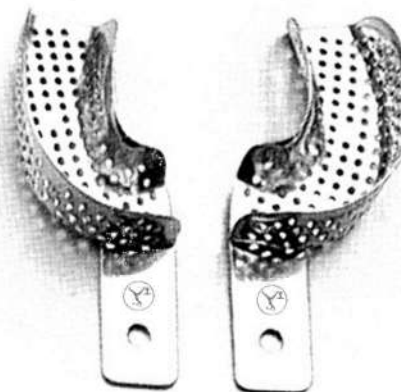

**841390**  
SL  
PARZIALE SINISTRA  
Superiore-Sinistra  
Inferiore-Destra

## INFERIORE

**841315**  
XXS – U1  
mm56\*44



**841325**  
XS – U2  
mm66\*50

**841335**  
S – U3  
mm70\*52

**841345**  
M – U4  
mm73\*56

**841355**  
L – U5  
mm76\*58

**841365**  
XL – U6  
mm78\*60

# PORTA IMPRONTE – Monouso

SENZA BORDINO RITENTIVO



**845100**  
KIT PORTA-IMPRONTE  
MONOUSO 24 PZ  
ASSORTITI

**845105**  
KIT PORTA-IMPRONTE  
MONOUSO 100 PZ  
ASSORTITI

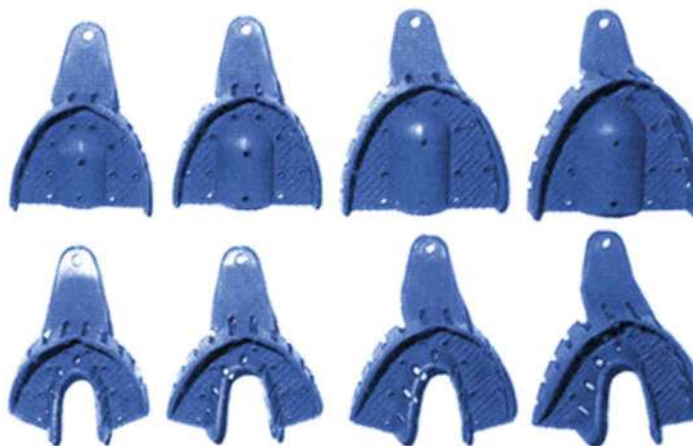

## SUPERIORE

- 845110** U1 - XXS mm61\*49
- 845120** U2 - XS mm65\*53
- 845130** U3 - S mm70\*59
- 845140** U4 - M mm73\*63

## INFERIORE

- 845115** L1 - XXS mm61\*50
- 845125** L2 - XS mm67\*52
- 845135** L3 - S mm72\*56
- 845145** L4 - M mm74\*58

## FILO RETRATTORE

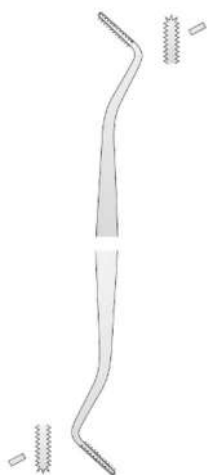
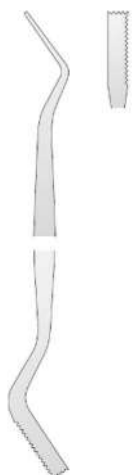

**368520**  
QUADRO

**368540**  
UNIVERSALE

**368560**  
TONDO



- 845180** S Superiore-Sinistra  
Inferiore-Destra
- 845185** S Superiore-Destra  
Inferiore-Sinistra
- 845190** XXS Superiore-Sinistra  
Inferiore-Destra
- 845195** XXS Superiore-Destra  
Inferiore-Sinistra



# CALIBRI



**882310**  
 CASTROVIEJO  
 mm85  
 0-20mm



**882320**  
 CASTROVIEJO  
 mm85 Curva  
 0-20mm



**882510**  
 MSY



**882720**  
 BEERENDONK

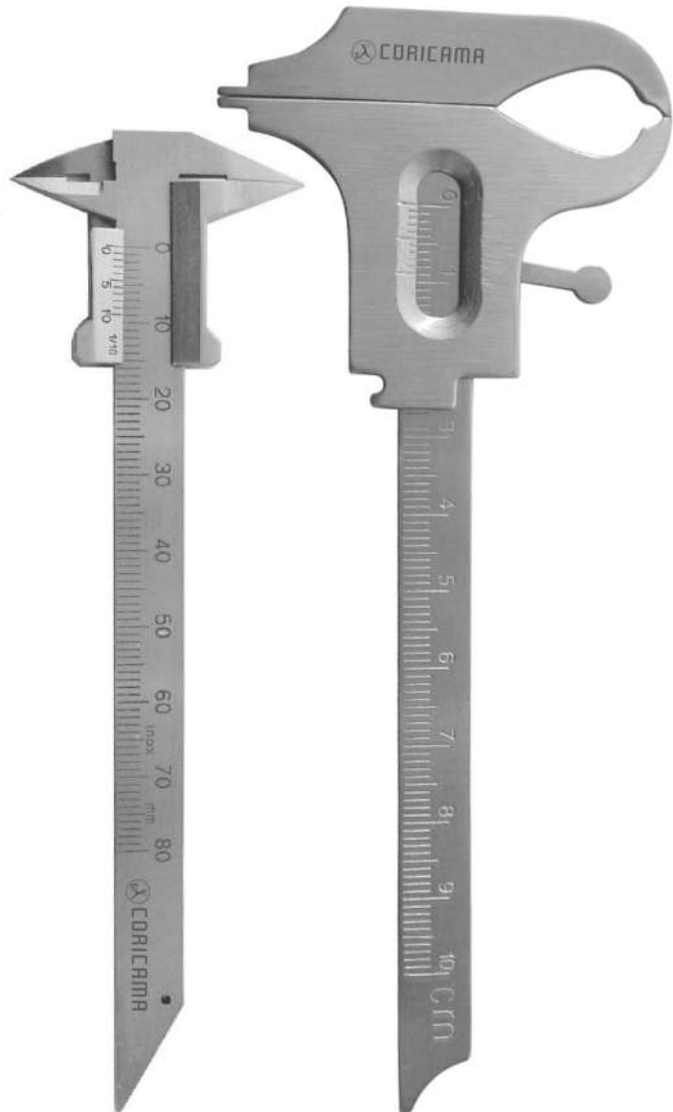

**882730**  
 ZURICHER



**882740**  
 BOLEY  
 mm145



**882450**  
 IWANSON  
 PER CERA



**882470**  
 IWANSON  
 PER METALLO



**882760**  
 RULER

# CALIBRI

PROTESICA 813



**882110**  
SPESSIMETRO  
mm145



**882210**  
SPESSIMETRO  
mm155



**882410**  
CALIBRO CASTROVIEJO  
mm180



**882420**  
CALIBRO CASTROVIEJO  
CURVO  
mm180



**882640**  
PROFONDIMETRO



CORICAMA



**CORICAMA**<sup>®</sup>  
since 1873

ACCESSORI

# VASSOI PER STERILIZZAZIONE – GAMMAFIX®



**911210**  
Silicone - Verde



**911230**  
Silicone - Rosso



**911240**  
Silicone - Giallo



**911250**  
Silicone - Blu



L 185 mm

H 35 mm

W 73 mm



L 130 mm

H 35 mm

W 185 mm

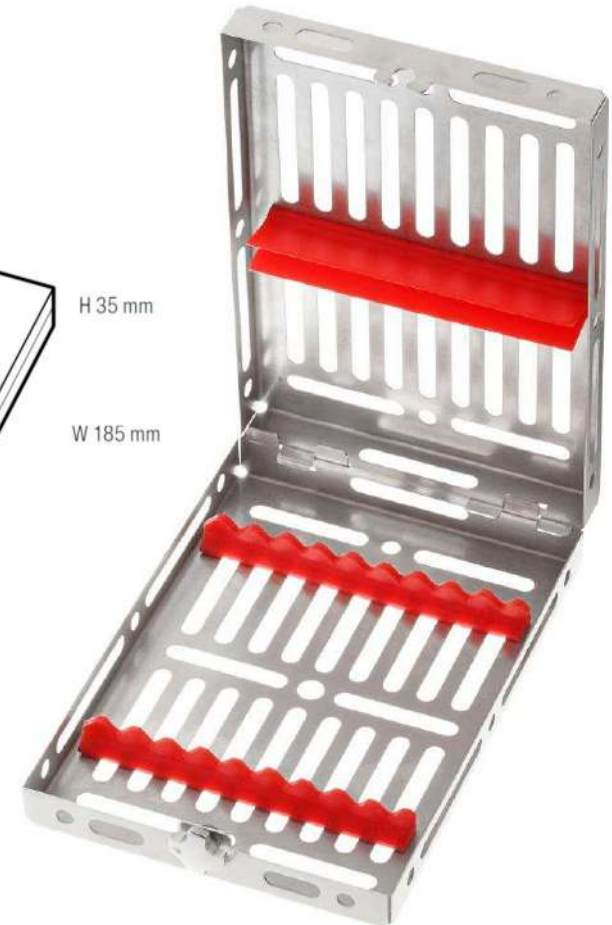

**911010**  
Silicone - Verde



**911030**  
Silicone - Rosso



**911040**  
Silicone - Giallo



**911050**  
Silicone - Blu

# VASSOI PER STERILIZZAZIONE – GAMMAFIX®

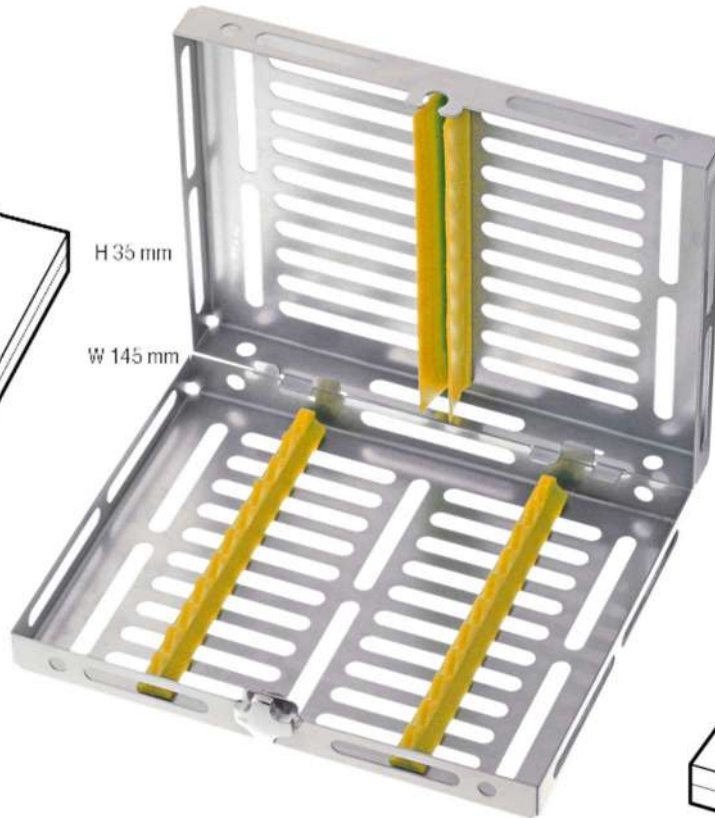

**911610**  
Silicone - Verde



**911630**  
Silicone - Rosso



**911640**  
Silicone - Giallo



**911650**  
Silicone - Blu

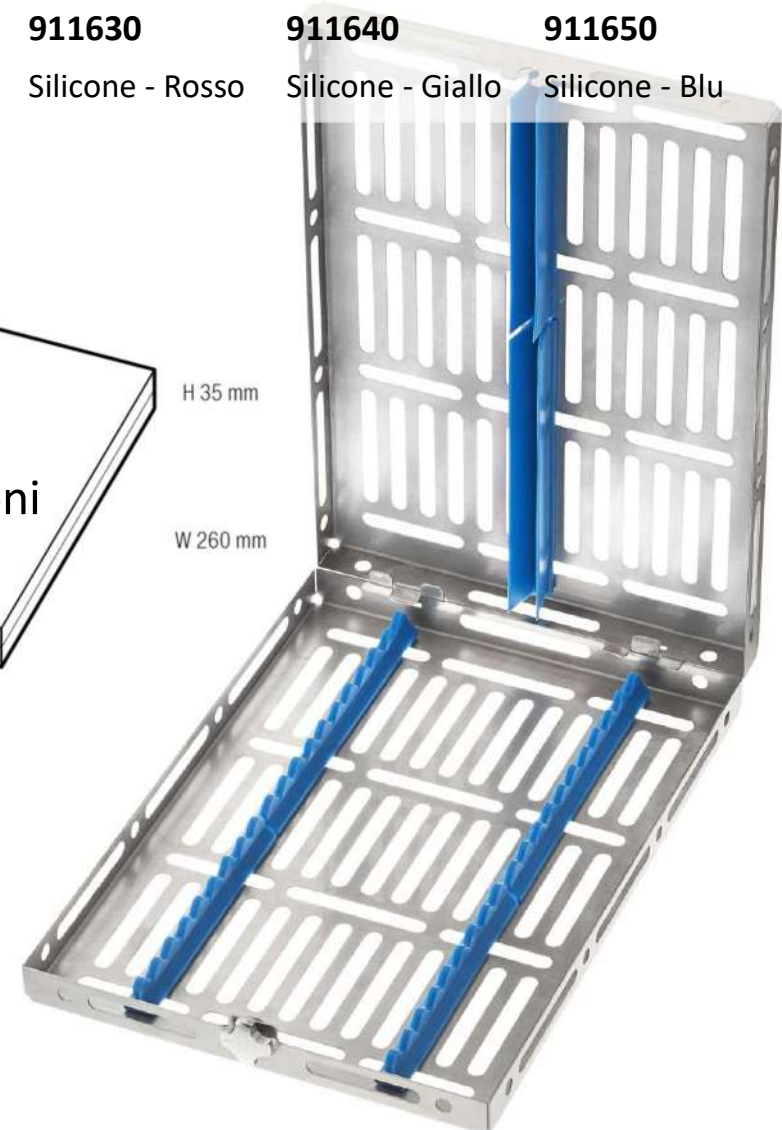

**911410**  
Silicone - Verde



**911430**  
Silicone - Rosso



**911440**  
Silicone - Giallo



**911450**  
Silicone - Blu

# VASSOI PER STERILIZZAZIONE – GAMMAFIX®



**911810**

Silicone - Verde

**911830**

Silicone - Rosso

**911840**

Silicone - Giallo

**911850**

Silicone - Blu



H 35 mm

W 185 mm

L 290 mm

OPEN



L'esclusivo sistema di bloccaggio GAMMAFIX mantiene il vassoio perfettamente chiuso in tutte le condizioni.

CLOSED



Il marchio mostra il lato di apertura (laterale) e chiusura (IN SU)



Gli spigoli aperti consentono all'acqua ed ai residui di defluire dal vassoio e riducono i tempi di asciugatura.



GAMMAFIX™

# VASSOI PER STERILIZZAZIONE – CESTELLI PER STERILIZZAZIONE

**913320**

VASSOIO PICCOLO

Per 5 strumenti

mm185\*85\*20

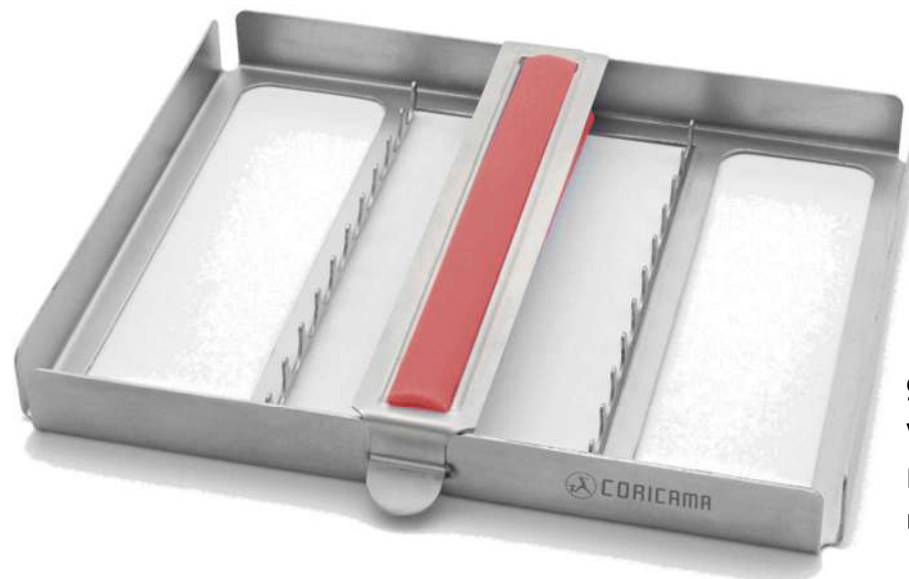
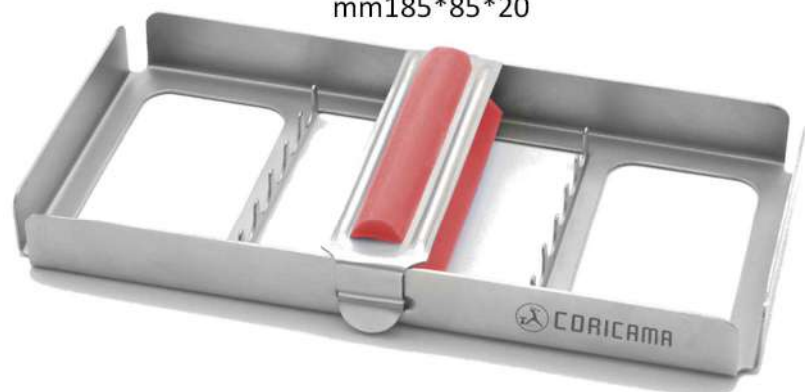

**913340**

VASSOIO MEDIO

Per 10 strumenti

mm185\*150\*20

Cestelli cilindrici per sterilizzazione in acciaio inox, con fasce scorrevoli e chiusura a cerniera.



**915320**

CESTELLO PER STERILIZZARE

N.3

mmø100\*120



**915340**

CESTELLO PER STERILIZZARE

N.2

mmø120\*120



**915360**

CESTELLO PER STERILIZZARE

N.1

mmø160\*140



**915380**

CESTELLO PER STERILIZZARE

N.0

mmø190\*160

# VASSOI UNIVERSALI – PICCOLI



**921220**  
VASSOIO PICCOLO  
mm185\*140\*15



**921225**  
COPERCHIO PICCOLO  
mm190\*145\*25



**921420**  
VASSOIO PICCOLO  
FORATO  
mm185\*140\*15



**921425**  
COPERCHIO PICCOLO  
FORATO  
mm190\*145\*25



**921520**  
RASTRELLIERA  
8 posizioni  
mm185\*140\*15



**921243**  
VASSOIO PICCOLO  
ALLUMINIO  
mm185\*140\*15



**921248**  
COPERCHIO PICCOLO  
ALLUMINIO  
mm190\*145\*25



**921443**  
VASSOIO PICCOLO  
FORATO  
ALLUMINIO  
mm185\*140\*15



**921448**  
COPERCHIO PICCOLO  
FORATO  
ALLUMINIO  
mm190\*145\*25



**921523**  
RASTRELLIERA  
8 posizioni  
ALLUMINIO  
mm185\*140\*15



# VASSOI UNIVERSALI – GRANDI



**921620**  
VASSOIO GRANDE  
mm285\*185\*15



**921625**  
COPERCHIO GRANDE  
mm290\*190\*30



**921820**  
VASSOIO GRANDE  
PERFORATO  
mm285\*185\*15



**921825**  
COPERCHIO GRANDE  
PERFORATO  
mm290\*190\*30



**921920**  
RASTRELLIERA  
23 posizioni  
mm285\*185\*15

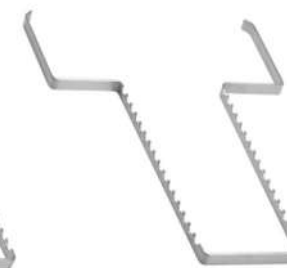

**921925**  
RASTRELLIERA  
16 posizioni  
mm285\*185\*15



**921643**  
VASSOIO GRANDE  
ALLUMINIO  
mm285\*185\*15



**921648**  
COPERCHIO GRANDE  
ALLUMINIO  
mm290\*190\*30

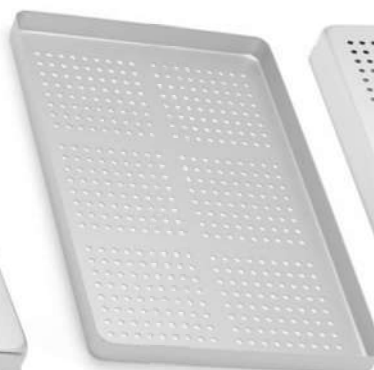

**921843**  
VASSOIO GRANDE  
PERFORATO  
ALLUMINIO  
mm285\*185\*15



**921848**  
COPERCHIO GRANDE  
PERFORATO  
ALLUMINIO  
mm290\*190\*30



**921953**  
RASTRELLIERA  
17 posizioni  
ALLUMINIO  
mm285\*185\*15

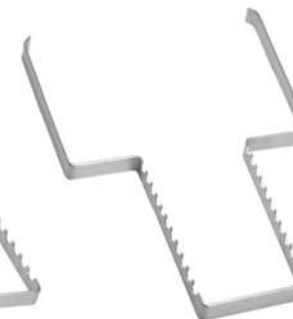

**921958**  
RASTRELLIERA  
11 posizioni  
ALLUMINIO  
mm285\*185\*15

# VASSOI UNIVERSALI



**923220**  
VASCHETTA

Capacità: 0,4 Litri  
mm220\*175\*25



**923240**  
VASCHETTA CON COPERCHIO  
PICCOLO

Capacità: 0,9 Litri  
mm220\*170\*40



**923260**  
VASCHETTA CON COPERCHIO  
GRANDE

Capacità: 2,0 Litri  
mm320\*220\*50



**923420**  
VASCHETTA  
RENIFORME N.1  
Capacità: 0,5 Litri  
mm220\*120

**923425**  
COPERCHIO  
VASCHETTA  
RENIFORME N.1  
mm220\*120



**923440**  
VASCHETTA  
RENIFORME N.2  
Capacità: 1,2 Litri  
mm310\*190

**923445**  
COPERCHIO  
VASCHETTA  
RENIFORME N.2  
mm310\*190

# CONTENITORI e TAZZE PER MISCELAZIONE



**923520**

CONTENITORE

N.0

Ø mm40

Capacità: 0,02 Litri



**923540**

CONTENITORE

N.1

Ø mm60

Capacità: 0,05 Litri



**923560**

CONTENITORE

N.2

Ø mm80

Capacità: 0,1 Litri



**923620**

CONTENITORE

CON MANICO

Ø mm25

Capacità: 0,01 Litri



**923720**

CONTENITORE

GRADUATO

Gradazione volumetrica in ML

Capacità: 0,025 Litri



**923820**

TAZZE PER ALGINATO

E GESSO

Gomma

Capacità: 0,3 Litri

Ø mm100



**923840**

TAZZE PER ALGINATO

E GESSO

Gomma

Capacità: 0,5 Litri

Ø mm120



**923860**

TAZZE PER ALGINATO

E GESSO

Gomma

Capacità: 0,8 Litri

Ø mm140

# CONTENITORI E DISTRIBUTORI



**942113**  
PORTA RIFIUTI  
ALLUMINIO VERDE  
ø mm70\*75



**942123**  
PORTA RIFIUTI  
ALLUMINIO ARGENTO  
ø mm70\*75



**942133**  
PORTA RIFIUTI  
ALLUMINIO ROSSO  
ø mm70\*75



**942143**  
PORTA RIFIUTI  
ALLUMINIO ORO  
ø mm70\*75



**942153**  
PORTA RIFIUTI  
ALLUMINIO BLU  
ø mm70\*75



**942323**  
DISTRIBUTORE BICCHIERI  
ALLUMINIO ARGENTO  
mm85\*85\*360



**942213**  
DISTRIBUTORE  
COTONE  
ALLUMINIO VERDE  
ø mm55\*75



**942223**  
DISTRIBUTORE  
COTONE  
ALLUMINIO ARGENTO  
ø mm55\*75



**942233**  
DISTRIBUTORE  
COTONE  
ALLUMINIO ROSSO  
ø mm55\*75



**942243**  
DISTRIBUTORE  
COTONE  
ALLUMINIO ORO  
ø mm55\*75

**942253**  
DISTRIBUTORE  
COTONE  
ALLUMINIO BLU  
ø mm55\*75

**942343**  
ALLUMINIO BIANCO

**942353**  
ALLUMINIO BLU



**CORICAMA**<sup>®</sup>  
since 1873

USO, MANUTENZIONE  
E CURA DELLO STRUMENTO

# USO, MANUTENZIONE E CURA DELLO STRUMENTO

Gli strumenti CORICAMA sono forniti 'NON STERILI': lavare, pulire, risciacquare, asciugare e sterilizzare prima di ogni utilizzo.

Gli strumenti devono essere immediatamente puliti e disinfettati dopo ogni operazione utilizzando le soluzioni di pulizia e le procedure corrette.

Scegliere il corretto dosaggio della soluzione detergente, la giusta durata e la temperatura ottimale del lavaggio/sterilizzazione.

**IMPORTANTE:** Seguire attentamente le procedure e le istruzioni fornite dai produttori delle soluzioni di pulizia e delle attrezzature di sterilizzazione.

Le operazioni di sterilizzazione e di pulizia devono essere effettuate esclusivamente in aree opportunamente attrezzate e specificatamente assegnate a questo scopo.

Tutti gli strumenti devono essere sempre controllati e testati prima di ogni utilizzo. Difetti o deformazioni influenzano il corretto funzionamento dello strumento.

L'utilizzo di strumenti difettosi è severamente vietato.

Strumenti danneggiati o usurati devono essere immediatamente sostituiti. Strumenti danneggiati o difettosi possono essere riparati o sostituiti solo da CORICAMA.

Gli strumenti CORICAMA sono resistenti a corrosione e scolorimento.

Quando gli strumenti sono sottoposti per un tempo maggiore o a temperature più elevate di quanto raccomandato, o puliti con soluzioni sbagliate o detergenti con concentrazioni chimiche più alte di quelle consigliate (ipoclorito di sodio, candeggina, acido tartarico, smacchianti, acidi per la rimozione del tartaro, acqua regia, acido solforico, acido cloridrico o iodio, ecc.), gli strumenti potrebbero essere intaccati da ruggine, corrosione, ossidazione e scolorimento.

Pulire gli strumenti con una garza e alcol al fine di eliminare eventuali residui o resti di materiale composito. Questo rende più facile la pulizia ad ultrasuoni ed evita di danneggiare in modo permanente la finitura superficiale degli strumenti con la rimozione manuale di eventuali residui dopo l'asciugatura.

**STRUMENTI IN ACCIAIO INOSSIDABILE** possono essere puliti con pulizia manuale, termodisinfettori, pulizia ad ultrasuoni e sterilizzazione in autoclave.

Sterilizzazione a caldo: gli strumenti in acciaio inossidabile possono essere sterilizzati a caldo ad una temperatura non superiore a 350°F/177°C secondo le istruzioni del produttore dell'autoclave.

**STRUMENTI CON MANICO IN POLIMERO** possono essere puliti con pulizia manuale, termodisinfettori, pulizia ad ultrasuoni e sterilizzazione in autoclave.

Sterilizzazione a caldo: gli strumenti con manico in polimero possono essere sterilizzati a caldo ad una temperatura non superiore a 275°F/135°C secondo le istruzioni del produttore dell'autoclave.

Gli strumenti con manico in polimero non sono compatibili con sterilizzatori a caldo secco o sterilizzatori a caldo secco rapidi.

**STRUMENTI IN ALLUMINIO ANODIZZATO** possono essere puliti con pulizia manuale, termodisinfettori e sterilizzazione in autoclave separatamente dagli strumenti in acciaio inossidabile.

Non pulire gli strumenti in alluminio anodizzato con la pulizia ad ultrasuoni.

La colorazione degli strumenti in alluminio può subire alterazioni con l'utilizzo di alcuni prodotti chimici. Non utilizzare prodotti troppo acidi o alcalinici, nonché prodotti contenenti Sodio o Potassio. Leggere attentamente le istruzioni d'uso dei prodotti di lavaggio senza scordare le incompatibilità con l'alluminio. Si consiglia di utilizzare soluzioni chimiche con un pH tra 4 e 8.

Sterilizzazione a caldo: gli strumenti in alluminio anodizzato possono essere sterilizzati a caldo ad una temperatura non superiore a 350°F/177°C secondo le istruzioni del produttore dell'autoclave.

**STRUMENTI IN TITANIO** possono essere puliti con pulizia manuale, termodisinfettori e sterilizzazione in autoclave separatamente dagli strumenti in acciaio inossidabile.

Non pulire gli strumenti in titanio con la pulizia ad ultrasuoni.

Sterilizzazione a caldo: gli strumenti in titanio possono essere sterilizzati a caldo ad una temperatura non superiore a 350°F/177°C secondo le istruzioni del produttore dell'autoclave.

# USO, MANUTENZIONE E CURA DELLO STRUMENTO

## PROCEDURE DI PULIZIA E STERILIZZAZIONE

**IMPORTANTE:** Seguire attentamente le procedure e le istruzioni fornite dai produttori delle soluzioni di pulizia e delle attrezzature di sterilizzazione.

### 1 PULIZIA MANUALE DEGLI STRUMENTI

- Sporczia e residui devono essere rimossi dagli strumenti.
- Utilizzare una garza e alcol al fine di eliminare eventuali residui o resti di materiale composito.
- Gli strumenti composti da più componenti devono essere smontati o almeno aperti.
- Pre-risciacquare con acqua calda a circa 95°F/35°C.
- Immergere gli strumenti in acqua calda per almeno 5 minuti.
- Pulirli con una spazzola morbida sotto l'acqua calda fino ad eliminare i residui visibili e prestando particolare attenzione a cavità, fori o giunture.
- Immergere gli strumenti in una soluzione di disinfezione adeguata non corrosiva con un pH neutro. Usa solo soluzioni di pulizia testate e approvate. Non usare mai candeggina o smacchiatori per la rimozione del tartaro. Non utilizzare spazzole o materiali abrasivi per pulire gli strumenti.
- Risciacquare con acqua calda a circa 95°F/35°C per rimuovere la soluzione di disinfezione degli strumenti.

### 2 PULIZIA AD ULTRASUONI

- Utilizzare la pulizia ad ultrasuoni per 15 minuti a 104°F/40°C con detergente enzimatico o neutro (una soluzione di pulizia con pH neutro).
- La soluzione deve essere cambiata ogni 8 ore (almeno una volta al giorno) per evitare ai microrganismi di accumularsi.
- Nota: la pulizia ad ultrasuoni non rimuove il cemento indurito o residui di composito. Vedi la precedente procedura di pulizia per rimuovere il cemento o residui di composito, mentre è ancora morbido e non asciutto.
- Risciacquare gli strumenti accuratamente sotto acqua calda corrente a circa 95°F/35°C e immergerli in alcol dopo il risciacquo.

Asciugare accuratamente gli strumenti prima della sterilizzazione per prevenire macchie, aloni, ruggine, corrosione e scolorimento.

### 3 STERILIZZAZIONE DEGLI STRUMENTI

- **IMPORTANTE:** gli strumenti devono essere puliti e accuratamente asciugati prima di essere confezionati e sterilizzati per evitare macchie, aloni, ruggine, corrosione e scolorimento.
- Strumenti con snodo: tenere tutti gli strumenti con snodo in posizione aperta durante la sterilizzazione.
- Per prevenire la ruggine, la corrosione e indurimento degli snodi e per assicurare un corretto funzionamento: tenaglie, rongeurs, forbici, pinze, pinze ortodontiche e tutti gli altri strumenti con snodo devono essere lubrificati con il corretto lubrificante (Olio Lubrificante CORICAMA – non utilizzare lubrificanti per la casa o lubrificanti non indicati per uso medico).
- Sterilizzare non oltre i 350°F/177°C (275°F/135°C per gli strumenti con manico in polimero)
- Tempo di asciugatura e raffreddamento: almeno 10 minuti
- Utilizzare contenitori aperti o forati, non utilizzare contenitori chiusi/non forati
- Gli strumenti non avvolti nella busta di sterilizzazione risulteranno nuovamente contaminati dopo il ciclo di sterilizzazione
- Prestare particolare attenzione agli oggetti in plastica e gomma che potrebbero danneggiarsi.
- Ulteriori raccomandazioni per evitare macchie, aloni, ruggine, corrosione e scolorimento:
- Utilizzare solo acqua distillata per il serbatoio in quanto l'acqua troppo "dura" può lasciare depositi
- La camera di sterilizzazione ed i filtri vanno puliti ogni settimana o secondo le raccomandazioni del produttore
- Non sovraccaricare e mantenere gli strumenti e le cassette leggermente separati sulle griglie all'interno della camera

# USO, MANUTENZIONE E CURA DELLO STRUMENTO

- Tenere gli strumenti di metalli diversi (acciaio inox, alluminio, titanio, cromo, etc.) in vassoi separati.
- Macchie, aloni o contaminazione di ruggine possono verificarsi quando ci sono già altri strumenti contaminati nello sterilizzatore: sterilizzare separatamente gli strumenti contaminati
- Una sterilizzazione ad una temperatura più alta e per un tempo superiore a quelli proposti indebolisce la tempra dello strumento (abbassando la sua performance) e scurisce lo strumento con un colore giallo/marrone simile all'ossidazione.

## STOCCAGGIO DEGLI STRUMENTI

Mantenere gli strumenti sterilizzati avvolti e sigillati all'interno della loro busta di sterilizzazione, e conservarli in un ambiente asciutto, pulito e privo di polvere ad una temperatura moderata da 41°F/5°C a 104°F/40°C.

## GESTIONE DEGLI STRUMENTI

Le cassette per sterilizzazione GAMMAFIX® permettono di spostare gli strumenti senza toccarli o danneggiarli e riducendo la possibilità di lesioni.

- Gli strumenti possono essere organizzati in modo sistematico in base al trattamento da fare evitando di perdere tempo alla ricerca degli strumenti mancanti.
- Gli strumenti sono tenuti insieme durante i processi di pulizia, lavaggio e asciugatura riducendo il rischio di rotture o di smarrimento.
- Le cassette contenenti gli strumenti sono pronte per l'uso o per lo stoccaggio dopo essere state confezionate e messo in autoclave per la sterilizzazione.





**CORICAMA**<sup>®</sup>  
since 1873

TERMINI E CONDIZIONI

# TERMINI E CONDIZIONI

## Condizioni di Utilizzo

I presenti Termini e Condizioni si applicano nei rapporti tra CORICAMA srl (di seguito "CORICAMA") e le controparti con cui CORICAMA è o entrerà in contatto (di seguito "Utente") e riguardano i Prodotti e Servizi offerti da CORICAMA, i contenuti (di seguito "Contenuti") del Sito web [www.coricama.it](http://www.coricama.it) (di seguito "Sito") e di tutti i Cataloghi, Schede prodotto, Manuali d'Uso, Flyer Pubblicitari e Promozionali, Marchi, Loghi, Video, Immagini, Testi (di seguito "Documenti e Materiali Informativi") di proprietà di CORICAMA.

UTILIZZANDO IL SITO ED I DOCUMENTI E MATERIALI INFORMATIVI, L'UTENTE ACCETTA I PRESENTI TERMINI E CONDIZIONI

I PRODOTTI CORICAMA SONO DESTINATI ESCLUSIVAMENTE A OPERATORI DEL SETTORE SANITARIO: Aprendo la confezione di un prodotto CORICAMA, l'Utente dichiara di aver letto e accettato tutti i termini e le condizioni, la garanzia, le istruzioni d'uso, cura e manutenzione del prodotto, disponibili sul [www.coricama.it](http://www.coricama.it).

L'Utente è tenuto a verificare regolarmente la presenza di eventuali modifiche.

Per informazioni specifiche riguardanti un Prodotto, ricercare il Codice Articolo su [www.coricama.it](http://www.coricama.it).

CORICAMA si riserva il diritto di cambiare, modificare, aggiungere o rimuovere clausole dei presenti Termini e Condizioni a propria discrezione e in qualsiasi momento.

L'Utente è tenuto a consultare periodicamente i Termini e Condizioni per verificare eventuali cambiamenti. L'utilizzo del Sito e dei Documenti e Materiali Informativi in seguito alla pubblicazione di modifiche costituirà l'accettazione di tali modifiche da parte dell'Utente.

Fermo restando il rispetto delle presenti condizioni di utilizzo, CORICAMA concede all'Utente il diritto personale, non esclusivo, non trasferibile e limitato di accedere al Sito e ai Documenti e Materiali Informativi e utilizzarli unicamente per finalità concordate con e autorizzate da CORICAMA.

## Contenuti

Il Sito ed i Documenti e Materiali Informativi contengono informazioni indirizzate ad operatori professionali sanitari.

Qualora l'Utente non sia un operatore professionale sanitario o non accetti ogni testo, grafica, interfaccia Utente, interfaccia visiva, fotografia, immagini, suoni, loghi e marchi, inclusi senza alcuna limitazione le informazioni, le descrizioni, il design, la struttura, la selezione, il coordinamento, l'espressione, l'aspetto e la disposizione di tali contenuti del Sito o degli altri Documenti e Materiali Informativi, DEVE ASTENERSI DALL'UTILIZZARE IL SITO ED I DOCUMENTI E MATERIALI INFORMATIVI

## Proprietà

Il Sito e i Documenti e Materiali Informativi sono di proprietà di CORICAMA (o sono controllati o concessi in licenza a CORICAMA da Terze Parti) e sono protetti dalle leggi in materia di brevetti e marchi commerciali, nonché dalle normative sui diritti di proprietà intellettuale e sulla concorrenza sleale. È vietato copiare, riprodurre, ripubblicare, caricare, pubblicare, visualizzare pubblicamente, codificare, tradurre, trasmettere o distribuire qualsiasi parte del Sito o dei Documenti e Materiali Informativi su qualsivoglia computer, server, sito web o altro mezzo destinato alla pubblicazione, alla distribuzione o a qualsiasi finalità commerciale senza previo consenso scritto da parte di CORICAMA.

L'Utente potrà utilizzare i contenuti del Sito o dei Documenti e Materiali Informativi comprese le informazioni sui Prodotti e i servizi previo consenso scritto da parte di CORICAMA a patto che non rimuova alcuna notifica di proprietà o copyright dalle copie di tali contenuti, utilizzi le informazioni unicamente per finalità concordate con e autorizzate da CORICAMA e non alteri in alcun modo le informazioni e non rilasci alcun tipo di dichiarazione o garanzia aggiuntiva relativamente a tali Contenuti.

La denominazione CORICAMA, i loghi, e i Prodotti e servizi correlati, sono marchi registrati CORICAMA di proprietà di CORICAMA.

# TERMINI E CONDIZIONI

Gli altri marchi citati sono utilizzati da CORICAMA con l'autorizzazione del rispettivo proprietario, oppure come semplice indicazione di Prodotti o servizi proposti da CORICAMA. La riproduzione, la copia, l'utilizzo o l'apposizione di detti marchi in assenza della preventiva autorizzazione di CORICAMA o dei rispettivi proprietari costituisce un reato di contraffazione punibile secondo i termini di legge.

## Uso del Sito e dei Documenti e Materiali Informativi da parte dell'Utente

Non è consentito utilizzare dispositivi, programmi, metodologie o algoritmi automatici, né processi manuali per acquisire, copiare o monitorare qualsiasi parte del Sito o dei Documenti e Materiali Informativi; è altresì vietato riprodurre o aggirare la struttura di navigazione o la presentazione del Sito, dei Documenti e Materiali Informativi o dei loro Contenuti per ottenere o tentare di ottenere materiali, documenti o informazioni con mezzi non resi intenzionalmente disponibili da CORICAMA.

CORICAMA si riserva il diritto di bloccare qualsiasi attività di questo tipo.

L'Utente deve astenersi dal cercare di ottenere l'accesso non autorizzato a qualsiasi parte o funzionalità del Sito, o ad altri sistemi o network collegati al Sito o a qualsiasi server CORICAMA, come pure ai servizi offerti su o attraverso il Sito, mediante tecniche di hacking, intercettazione delle password o qualsiasi altro mezzo illegale. È fatto divieto di sondare, esaminare o testare la vulnerabilità del Sito o di qualsiasi rete a esso collegata, nonché di violarne la sicurezza o le misure di autenticazione. Non è consentito effettuare operazioni di reverse lookup, tracciare o cercare di tracciare l'origine di informazioni relative a qualsiasi Utente o visitatore del Sito, o qualsiasi cliente CORICAMA. È altresì proibito sfruttare il Sito o i servizi e le informazioni resi disponibili o offerti tramite il Sito allo scopo di rivelare qualsiasi informazione relativa a terzi.

L'Utente accetta di astenersi dal compiere azioni che provochino un carico di lavoro irragionevole o sproporzionato sull'infrastruttura del Sito o i sistemi e le reti CORICAMA, o sui sistemi e le reti collegati al Sito o a CORICAMA.

L'Utente accetta di non utilizzare alcun tipo di dispositivo, software o routine per interferire o tentare di interferire con il corretto funzionamento del Sito o di qualsiasi transazione condotta sullo stesso, nonché con l'utilizzo del Sito da parte di terzi.

L'Utente accetta inoltre di non utilizzare il Sito o i Documenti e Materiali Informativi per attività proibite dalla legge o dalle presenti Termini e Condizioni, nonché di astenersi dal sollecitare lo svolgimento di qualsiasi attività illegale o in violazione dei diritti di CORICAMA o di altri.

## Giurisdizione, legge applicabile e foro competente

Per qualsiasi controversia tra le parti in merito al presente contratto sarà di esclusiva competenza del foro di Pordenone – ITALIA

## **Condizioni generali di vendita & resi**

Le presenti condizioni generali hanno per oggetto l'acquisto di Prodotti CORICAMA.

Effettuando un Ordine d'Acquisto dal Sito o nelle varie modalità previste, l'Utente dichiara di aver preso visione e di accettare integralmente tutti i Termini e Condizioni.

Per poter effettuare un Ordine d'Acquisto dal Sito è necessario che l'Utente sia registrato al Sito e fornisca alcuni semplici dati, utili alla gestione dell'ordine come ad esempio: nome e cognome/ragione sociale, indirizzo e-mail, numero di telefono, indirizzo di spedizione e dati di fatturazione.

All'Utente è severamente vietato fornire dati falsi e/o inventati e/o di fantasia nella procedura di registrazione necessaria ad attivare nei suoi confronti l'iter per l'esecuzione del presente accordo di vendita e le relative ulteriori comunicazioni; i dati anagrafici e la e-mail devono essere esclusivamente i reali propri dati personali e non di terze persone. È espressamente vietato effettuare doppie registrazioni corrispondenti ad una sola persona o inserire dati di terze persone.

La Fattura viene rilasciata da CORICAMA attraverso il trasportatore o inviata a mezzo posta elettronica al momento della spedizione o della consegna dei Prodotti.

L'Utente solleva CORICAMA, da ogni responsabilità derivante dall'emissione di documenti fiscali errati a causa di errori relativi ai dati forniti dall'Utente, essendone l'Utente stesso unico responsabile della corretta comunicazione in caso di variazioni e/o del corretto inserimento.

# TERMINI E CONDIZIONI

## Prezzi di Vendita

Tutti i Prezzi dei Prodotti indicati sul Sito, NON sono comprensivi di IVA e costi di spedizione.

Ai Prodotti ed ai Servizi si applica il Prezzo evidenziato sul Sito al momento dell'invio dell'Ordine di Acquisto, senza alcuna considerazione di precedenti offerte o eventuali variazioni di Prezzo intervenute successivamente.

## Costi di Spedizione

La spedizione dei Prodotti è subordinata al pagamento da parte dell'acquirente del prezzo dei Prodotti e dei servizi connessi ed indicati nell'Ordine d'Acquisto.

Le spese di Spedizione e le spese relative agli ulteriori Servizi messi a disposizione da CORICAMA attraverso terze parti (sdoganamenti, certificati, ecc.), sono a carico del Cliente e saranno aggiunte ed adeguatamente dettagliate nell'Ordine di Acquisto.

CORICAMA non è responsabile dei danni causati dal vettore ai Prodotti acquistati.

## Tempi di Consegna

I Prodotti acquistati e disponibili saranno spediti entro 7 giorni dal momento del ricevimento dell'Ordine di Acquisto da parte di CORICAMA.

Sarà possibile verificare lo status della consegna attraverso il tracking del prodotto tramite un link o un numero di spedizione comunicato all'indirizzo e-mail dell'Acquirente al momento della spedizione.

## Modalità di consegna

CORICAMA provvederà a recapitare i Prodotti selezionati ed ordinati mediante corriere espresso presso l'indirizzo indicato dall'acquirente.

Qualsiasi impedimento o condizione particolare legata alla consegna relativamente alle vie d'accesso all'indirizzo indicato che dovesse impedire o rendere meno agevole la consegna stessa, dovrà essere comunicata dall'acquirente in fase di Ordine d'Acquisto all'interno del campo "note".

In caso di impossibilità di consegnare il prodotto a causa di carenze informative da parte del Cliente, il costo sostenuto per la mancata consegna e la giacenza del prodotto saranno addebitati all'Acquirente.

La consegna, salvo diverso accordo scritto fra le parti, avverrà negli orari di lavoro di tutti i giorni non festivi. L'acquirente è tenuto a rendersi reperibile per il recapito, onde evitare gli eventuali addebiti aggiuntivi per mancate consegne da parte del corriere espresso che verteranno sull'Acquirente stesso.

Al momento della consegna, l'acquirente deve verificare il numero dei colli e che l'imballo dei Prodotti risulti integro, non danneggiato, né bagnato o alterato. Una volta sottoscritto il documento di trasporto del Corriere, il Cliente non potrà più opporre alcuna contestazione circa quantità ed integrità di quanto ricevuto. In caso di difformità, la stessa dovrà essere segnalata sul documento di trasporto del Corriere e confermata, entro 7 (sette) giorni via raccomandata a.r. a:

CORICAMA srl – Viale dell'Industria,1 – 33085 Maniago (PN) Italia.

Pur in presenza di imballo integro, la merce dovrà essere verificata entro 7 (sette) giorni dal ricevimento. Eventuali anomalie occulte, dovranno essere segnalate per iscritto a mezzo raccomandata a.r. a:

CORICAMA srl – Viale dell'Industria,1 – 33085 Maniago (PN) Italia.

Ogni segnalazione oltre i suddetti termini, non sarà presa in considerazione.

## Pagamento

Il pagamento potrà essere eseguito tramite BONIFICO/TT/SWIFT o carta di credito, alle condizioni di seguito descritte.

CORICAMA permette all'acquirente di eseguire il pagamento online tramite carta di credito in assoluta sicurezza grazie a un sistema di crittografia automatica delle informazioni e l'assistenza di un provider esterno che adotta sistemi tecnologici atti a garantire i massimi livelli di affidabilità, sicurezza, protezione e riservatezza nella trasmissione di informazioni via web.

L'addebito su carta di credito avverrà al momento della conferma dell'Ordine d'Acquisto da parte di CORICAMA. Nel caso in cui, per una ragione qualunque, l'addebito dell'importo dovuto dall'acquirente si riveli impossibile il processo di vendita viene automaticamente annullato con conseguente cancellazione dell'ordine di acquisto.

# TERMINI E CONDIZIONI

## Disponibilità dei Prodotti

L'Utente può acquistare i Prodotti attualmente presenti on-line nel Sito.

Qualora la richiesta dovesse superare la quantità disponibile per un dato articolo o ci fossero richieste particolari per Prodotti al momento non disponibili, CORICAMA accetterà l'acquisto limitatamente a quanto effettivamente a disposizione e concorderà con l'Utente (nei tempi e nei modi che riterrà più opportuno) se i Prodotti e quantità richieste ordinati saranno o no disponibili in futuro.

Le immagini contenute nel Sito e/o nei Documenti e Materiali Informativi sono puramente indicative. CORICAMA si riserva il diritto di apportare modifiche migliorative dei Prodotti senza nessun obbligo di preavviso.

## Diritto di recesso/annullamento Ordine d'Acquisto – Consumatore

Il diritto di recesso senza alcuna penalità è applicabile soltanto per gli acquisti effettuati a distanza tramite e-commerce ai soli consumatori ovvero "la persona fisica che agisce per scopi estranei all'attività imprenditoriale o professionale eventualmente svolta". Aziende e professionisti con Partita Iva non possono far valere il diritto di recesso per acquisti effettuati come tali.

Per esercitare il diritto di recesso, l'Utente deve informare CORICAMA entro il termine di 7 (sette) giorni da quando è stato consegnato il prodotto della propria decisione compilando il modulo RMA dall'area del Sito [www.coricama.it/en/rma/](http://www.coricama.it/en/rma/) o inviando il modulo RMA all'indirizzo email [info@coricama.it](mailto:info@coricama.it) (fa fede la data di consegna riportata sulla lettera di vettura del corriere).

CORICAMA invierà all'Utente una mail di conferma di esercizio del recesso, con il codice di autorizzazione al reso (RMA No.).

Entro e non oltre i successivi 7 (sette) giorni l'Utente dovrà trascrivere il codice di reso (RMA No.) sul modulo RMA e restituire i Prodotti a CORICAMA srl – Viale dell'Industria,1 – 33085 Maniago (PN) Italia, unitamente al modulo RMA idoneamente redatto e completo del codice di autorizzazione al reso (RMA No.). Il codice di autorizzazione al reso (RMA No.) dovrà essere indicato all'esterno dell'involucro in cui verrà collocato fisicamente il prodotto.

Le spedizioni prive di codice di autorizzazione al reso (RMA No.) verranno respinte.

I rischi e i costi diretti della restituzione dei beni saranno a carico dell'Utente.

Il prezzo del prodotto restituito, detratti i costi di consegna, sarà rimborsato entro 30 giorni dalla data del recesso o dalla data del ricevimento del prodotto per cui è stato esercitato il diritto di recesso, utilizzando lo stesso mezzo di pagamento usato dall'Utente per la transazione iniziale. Se l'Utente richiede il rimborso su diverso mezzo di pagamento, saranno a carico dell'Utente eventuali costi aggiuntivi derivanti dal diverso mezzo di pagamento. Il rimborso è sospeso fino al ricevimento della merce resa.

Il prodotto per cui è stato esercitato il diritto di recesso deve essere restituito integro NON utilizzato, manipolato esclusivamente per stabilire la natura, le caratteristiche e il funzionamento del prodotto.

Qualora il prodotto restituito risulti:

- danneggiato (ad esempio con segno di usura, abrasione, scalfittura, graffio, deformazioni, ecc.),
- utilizzato oltre quanto necessario per stabilire la natura, le caratteristiche e il funzionamento del prodotto
- non completo di tutti i suoi elementi ed accessori (confezione esterna e/o imballo interno originale, le etichette, i fogli illustrativi/istruzioni/note/manuali allegati, ecc.)

la restituzione del prodotto non sarà accettata ed il prodotto sarà rispedito all'Utente. I rischi e le spese di trasporto, sostenute per la consegna del prodotto all'Utente e per l'eventuale restituzione a CORICAMA non sono rimborsabili.

CORICAMA, non risarcirà l'Utente nel caso di furto, perdita o danneggiamento dei beni in fase di restituzione. Si consiglia di spedire con corrieri che forniscono il numero di spedizione e assicurano il tracking del pacco durante il trasporto.

In caso di danneggiamento del bene durante il trasporto, CORICAMA darà comunicazione dell'accaduto all'Utente entro 7 (sette) giorni dal ricevimento del bene nei propri magazzini, per consentirgli di sporgere tempestivamente denuncia nei confronti del corriere da lui scelto e ottenere il rimborso del valore del bene (se assicurato); in questa eventualità, il prodotto sarà messo a disposizione dell'Utente per la sua restituzione, annullando contemporaneamente la richiesta di recesso.

# TERMINI E CONDIZIONI

Per limitare danneggiamenti alla confezione originale, raccomandiamo, quando possibile, di inserirla in una seconda scatola, sulla quale apporre il codice di autorizzazione al reso (RMA No.); va evitata in tutti i casi l'apposizione di etichette o nastri adesivi direttamente sulla confezione originale del prodotto.

Qualora la confezione e/o l'imballo originale risultino rovinati, CORICAMA provvederà a trattenere dal rimborso dovuto una percentuale fino al 10% dello stesso, quale contributo alle spese di ripristino.

## Diritto di recesso/annullamento Ordine d'Acquisto – Aziende e professionisti con Partita Iva

Se il ritorno è dovuto ad un errore di ordine dell'Utente (Aziende e professionisti con Partita Iva), verrà trattenuto un importo pari al 30% del totale del valore restituito come rimborso spese.

L'importo già pagato non può essere rimborsato e darà luogo ad un buono acquisto avente la validità di un anno a partire dalla sua data di emissione. Trascorso tale termine, non sarà applicata nessuna deduzione.

## Responsabilità

CORICAMA non sarà ritenuta responsabile nei confronti dell'Utente per i ritardi o per la mancata esecuzione degli obblighi contrattuali provocati, in via diretta o indiretta, da cause di forza maggiore fuori dal proprio controllo, quali ad esempio: fenomeni naturali di particolare intensità, eventi bellici, embarghi, scioperi, restrizioni impreviste ordinate dalle autorità ecc.

In caso di forza maggiore, sarà facoltà delle parti accordarsi per annullare o sospendere il contratto.

CORICAMA non sarà ritenuta responsabile nei confronti dell'Utente in merito a danni, perdite e costi conseguenti, incidentali, indiretti o risarcitori (inclusi, ma non limitati a, interruzioni o perdite nell'attività di impresa, o perdite nei guadagni) anche se la loro eventuale esistenza sia stata resa nota, subiti a seguito della ritardata consegna o mancata esecuzione dell'accordo di vendita per le cause sopra citate, ovvero in merito a danni, perdite e costi subiti a seguito dell'uso o dell'impossibilità all'uso dei Prodotti acquistati.

CORICAMA non sarà ritenuta responsabile della perdita o dei danni subiti dall'Utente dovuti a ritardi, rallentamenti ed interruzioni del servizio di commercio elettronico del Sito.

CORICAMA non sarà ritenuta responsabile per eventuali danni che possano, direttamente o indirettamente, derivare a persone, cose o animali, in conseguenza di un uso improprio del prodotto.

## **Garanzia e modalità di assistenza**

CORICAMA si posiziona ai vertici della propria categoria per la qualità dei propri Prodotti.

CORICAMA garantisce che i Prodotti saranno privi di difetti di progettazione e di materiale nonché conformi alle descrizioni pubblicate sul Sito o sui Documenti e Materiali Informativi per un periodo di 2 (due) anni dalla data di consegna dei Prodotti all'Utente.

Eventuali difetti e non conformità devono essere comunicati entro e non oltre 7 (sette) giorni dalla scoperta, compilando dal Sito o trasmettendo a mezzo e-mail all'indirizzo [info@coricama.it](mailto:info@coricama.it), l'apposito modulo RMA correttamente compilato con le seguenti informazioni:

- Codice Articolo
- Lotto
- Quantità per ciascun Articolo / Lotto
- Indicazione del difetto e/o della non conformità riscontrati OPPURE “errato ordine”
- Numero della Fattura di acquisto
- Data della Fattura di acquisto comprovante la data di acquisto
- Indicazione del modo d'uso
- Indicazione del tipo di sterilizzazione
- Almeno n. 1 documento/immagine (OBBLIGATORIO) del prodotto.

A seguito del ricevimento del modulo RMA e della relativa documentazione/immagini, CORICAMA valuterà i difetti e le non conformità denunciati dall'Utente e, dopo avere effettuato i controlli qualitativi atti a verificare l'effettiva non conformità del prodotto, deciderà se autorizzare la restituzione del prodotto.

# TERMS AND CONDITIONS

Se la restituzione del prodotto viene autorizzata, CORICAMA fornirà all'Utente il codice di autorizzazione al reso (RMA No.) via e-mail all'indirizzo indicato nel modulo RMA.

Il prodotto deve essere restituito in perfette condizioni igieniche – sterile – per proteggere la salute dei lavoratori. In particolare, ogni prodotto deve sempre essere restituito nella busta di sterilizzazione (sigillata) dopo essere stato sterilizzato.

I Prodotti restituiti Non-Sterili o non sigillati nella busta di sterilizzazione non saranno accettati.

La restituzione (autorizzata da CORICAMA) sarà effettuata dall'Utente a proprie spese entro 7 (sette) giorni dal ricevimento del codice di autorizzazione al reso (RMA No.) al seguente indirizzo:

CORICAMA srl, Via Maniago 103 – 33085 Maniago (PN) – Italia

Il modulo RMA compilato con le informazioni sopra richieste e completo del codice di autorizzazione al reso (RMA No.) inviato da CORICAMA all'Utente via e-mail deve essere incluso nel pacco che contiene il prodotto oggetto del reso.

L'autorizzazione a restituire i Prodotti tramite il codice di autorizzazione al reso (RMA No.) non costituirà in alcun modo riconoscimento di difetti o non conformità, la cui esistenza dovrà essere accertata successivamente alla restituzione tramite valutazione da parte di CORICAMA.

I rischi ed i costi diretti della restituzione dei beni sono a carico dell'Utente. CORICAMA non risponde in caso di furto, perdita o danneggiamento del prodotto nel processo di restituzione. Si raccomanda di utilizzare vettori che forniscono il numero di tracking e che garantiscono la tracciabilità del pacco durante il trasporto.

Se il prodotto è danneggiato durante il trasporto, CORICAMA darà comunicazione all'Utente entro 7 (sette) giorni dal ricevimento del prodotto nei suoi magazzini, per consentirgli di sporgere tempestivamente denuncia nei confronti del corriere e ottenere il rimborso del valore del prodotto (se assicurato); in questo caso il prodotto sarà reso disponibile all'Utente.

Dopo la ricezione e valutazione del prodotto da parte di CORICAMA, qualora sia riconosciuto il difetto o non conformità, CORICAMA si riserva di riparare o sostituire il prodotto, o di rimborsare all'Utente il prezzo del prodotto pagato al momento dell'acquisto.

In caso di riparazione o sostituzione, il periodo di garanzia in corso non sarà interrotto o azzerato.

Se CORICAMA deciderà di rimborsare all'Utente il prezzo pagato per l'acquisto del prodotto, l'importo verrà detratto dal prezzo di acquisto di un nuovo prodotto di CORICAMA.

## Esclusione di garanzia

Sono esclusi dalla presente garanzia le difettosità dei Prodotti derivanti da:

- mancata osservanza delle istruzioni inserite all'interno del prodotto o presenti sul Sito.
- uso improprio o inadeguato (uso della forza, sovraccarico, modifiche eseguite dall'Utente, errata destinazione d'uso, negligenza).
- Danni indiretti ovvero danni da circostanze e/o eventi causati da forza maggiore, che comunque non possono farsi risalire a difetti di materiale o di fabbricazione del prodotto.
- Difetti dovuti a trascuratezza e/o errato e/o mancata manutenzione.
- Difetti dovuti a errata pulizia e sterilizzazione (macchie e/o tracce di ossidazione o ruggine dovuti al mancato rispetto delle tempistiche, temperature e procedure di disinfezione e sterilizzazione).
- Difetti riconducibili alla naturale usura del prodotto.

L'esecuzione degli obblighi a nostro carico, sopra descritti, presuppongono in ogni caso la restituzione da parte dell'Utente dei Prodotti risultino essi consegnati per errore, non conformi, danneggiati o difettosi.







**CORICAMA**<sup>®</sup>  
since 1873

INDICE - CODICE NUMERICO

# INDICE - CODICE NUMERICO

CODICE PAGINA	CODICE PAGINA	CODICE PAGINA	CODICE PAGINA	CODICE PAGINA	CODICE PAGINA	CODICE PAGINA
<b>10</b> <b>DIAGNOSTICA</b>	162560 103	212465 202	217540 207	224560 212	251550 217	315350 301
	162565 103	212470 202	217550 207	224570 212	251560 217	315410 301
	162585 103	212475 202	217560 207	225510 213	251570 217	315420 301
	162770 103	212480 202	217570 207	225520 213	251580 217	315440 301
110130 101	162780 103	214410 203	218510 208	225530 213	262510 218	315470 301
110220 101	170410 104	214435 203	218520 208	225540 213	262520 218	315490 301
110225 101	170415 104	214450 203	218530 208	225550 213	262530 218	315570 302
110620 101	170425 104	214460 203	218540 208	234510 214	262540 218	315610 302
110625 101	170440 104	214480 203	218550 208	234520 214	264520 218	315620 302
110810 101	170450 104	214485 203	218560 208	234540 214	264570 218	315650 302
110820 101	170455 104	214710 202	218570 208	234550 214	264580 218	315660 302
110830 101	170460 104	214715 202	219510 209	234560 214	272550 219	315730 302
112010 102;502	170465 104	215510 205	219520 209	235530 215	272560 219	315750 302
112030 102;502	170470 104	215520 205	219530 209	235535 215	272570 219	315830 303
113500 102	170475 104	215530 205	219540 209	235540 215	272580 219	315840 303;715
113700 102	170490 104	215540 205	219550 209	235545 215	291110 219	315860 303
113710 102	178420 105	215550 205	219560 209	235560 215	291120 219	315870 303
113800 102	178430 105	215560 205	219570 209	235570 215	291140 219	315880 303
113810 102	178440 105	215570 205	222530 211	235880 215	291150 219	321430 304
113840 102	178485 105	215580 205	222540 211	235890 215	291180 219	321460 304
113850 102	178490 105	215813 206	223510 211	236540 216	<b>30</b> <b>CONSERVATIVA</b>	321470 304
113860 102	<b>20</b> <b>PARODONTOLOGIA</b>	215823 206	223520 211	236550 216		322420 304
113880 102		215833 206	223530 211	236555 216		322440 304
133502 101		215843 206	223540 211	236570 216		323460 304
142020 106		215853 206	223550 211	236575 216	315230 303	323480 304
142040 106	212410 201	215863 206	223560 211	236580 216	315240 303	323490 304
142060 106	212420 201	215873 206	224510 212	251490 217	315250 303	324420 305
142080 106	212430 201	215883 206	224520 212	251510 217	315260 303	324430 305
161560 103	212440 201	217510 207	224530 212	251520 217	315270 303	324440 305
161565 103	212450 201	217520 207	224540 212	251530 217	315320 301	324450 305
161770 103	212460 201	217530 207	224550 212	251540 217	315330 301	324460 305

# INDICE - CODICE NUMERICO

CODICE PAGINA	CODICE PAGINA	CODICE PAGINA	CODICE PAGINA	CODICE PAGINA	CODICE PAGINA	CODICE PAGINA
324470 305	331802 309	335480 311	344420 315	355410 317	364520 321	37 ENDODONZIA
324480 305	331812 309	335490 311	344430 315	355420 317	364530 321	
324490 305	331822 309	336420 309	344440 315	355430 317	364700 321	
325410 306	331832 309	336440 309	344450 315	355440 317	364705 321	
325420 306	331837 309	336460 309	344470 315	355450 317	364710 321	370040 371
325440 306	331842 309	337430 312	345420 315	356420 318	364720 321	370050 371
325450 306	331852 309	337435 312	345430 315	356430 318	366130 322	370080 371
325460 306	331857 309	337450 312	345440 315	356440 318	366140 322	375890 371
325470 306	331862 309	337455 312	347220 316	356450 318	366150 322	375895 371
325480 306	331867 309	338420 312	347230 316	356470 318	366170 322	376420 371
325490 306	331877 309	338430 312	347240 316	356480 318	366180 322	376430 371
326410 307	331882 309	338460 313	347320 316	356490 318	366185 322	376440 371
326420 307	332420 310	338470 313	347330 316	359490 318	366190 322	383720 372
326430 307	332450 310	338480 313	347340 316	359495 318	367110 322	383740 372
326440 307	332480 310	339440 313	348210 316	359790 318	367120 322	383760 372
326460 307	333420 310	339450 313	348220 316	362210 319	367130 322	383780 372
326470 307	333440 310	339460 313	348230 316	362211 319	367140 322	384420 372
326480 307	333460 310	342410 314	349920 316	362220 319	367150 322	384430 372
326490 307	334420 310	342420 314	349930 316	362250 319	367160 322	384440 372
326495 307	334430 310	342430 314	349931 316	362251 319	367170 322	384460 372
327420 308	334440 310	342440 314	353410 317	362271 320	367180 322	384470 372
327440 308	334450 310	342450 314	353420 317	362280 320	367190 322	384480 372
327450 308	334470 311	342460 314	353430 317	362285 320	367260 322	386420 373
327460 308	334480 311	342470 314	353450 317	362295 320	367270 322	386430 373
327470 308	334490 311	342480 314	353460 317	363410 321	367280 322	386440 373
327480 308	335410 311	343420 314	353480 317	363450 321	368520 811	386450 373
327490 308	335420 311	343440 314	353490 317	363460 321	368540 811	386460 373
329860 308	335430 311	343450 314	354420 317	363470 321	368560 811	386470 373
329870 308	335440 311	343470 315	354430 317	364500 321		386480 373
329880 308	335460 311	343480 315	354440 317	364505 321		388720 373
329890 308	335470 311	344410 315	355400 317	364510 321		388740 373

# INDICE - CODICE NUMERICO

CODICE PAGINA	CODICE PAGINA	CODICE PAGINA	CODICE PAGINA	CODICE PAGINA	CODICE PAGINA	CODICE PAGINA	
388760 373	412175 401	422570 405	454460 409	515530 501	520481 505	520871 510	
388780 373	412180 401	422580 405	454480 409	515535 501	520520 506	520880 510	
399113 374	412199 401	422590 405	454490 409	515630 501	520521 506	520920 510	
399133 374	412220 402	441110 406	457230 410	515635 501	520530 506	520921 510	
399183 374	412225 402	441115 406	457240 410	518110 502	520531 506	520930 511	
399323 374	412230 402	441120 406	457250 410	518120 502	520560 506	520931 511	
399373 374	412235 402	441125 406	457260 410	518130 502	520561 506	520940 511	
399613 374	412240 402	443150 406	457330 410	518155 502	520570 506	520941 511	
399614 374	412260 402	445110 406	457340 410	518220 502	520571 506	520950 511	
399713 375	412265 402	445212 406	457350 410	518240 502	520640 507	520951 511	
399723 375	412270 402	445320 406	457360 410	518260 502	520641 507	535110 512	
399733 375	412275 402	445410 407	462260 410	518280 502	520660 507	535140 512	
399753 375	412280 402	445512 407	462270 410	520240 503	520661 507	535210 513	
399763 375	414110 403	447120 407	462271 410	520241 503	520670 507	535211 513	
399773 375	414120 403	447125 407	462290 410	520250 503	520671 507	535220 513	
399913 375	414130 403	447130 407	462291 410	520251 503	520720 508	535240 513	
399943 375	414140 403	447135 407	468210 411	520320 504	520721 508	535241 513	
399963 375	414150 403	447150 407	468215 411	520321 504	520740 508	535250 513	
399983 375	414160 403	447155 407	468512 411	520330 504	520741 508	535280 513	
40 IMPLANTOLOGIA	421500 404	447160 407	475520 411	520331 504	520770 508	536310 514	
	421510 404	452620 408	475530 411	520370 504	520771 508	536311 514	
	421520 404	452625 408	475740 411	520371 504	520790 508	536320 514	
	421530 404	452640 408	475750 411	520380 504	520791 508	536340 514	
412120 401	421540 404	452645 408	50 CHIRURGIA	520381 504	520830 509	536341 514	
	412125 401	421550 404		453620 408	520420 505	520831 509	536350 514
	412130 401	422510 405		453630 408	520421 505	520840 509	536360 514
	412135 401	422520 405		453645 408	520430 505	520841 509	537260 515
412140 401	422530 405	453655 408	515120 501	520431 505	520850 509	537261 515	
412160 401	422540 405	454420 409	515140 501	520470 505	520851 509	537270 515	
412170 401	422550 405	454430 409	515160 501	520471 505	520860 510	537360 515	
	422560 405	454450 409	515180 501	520480 505	520861 510	538410 515	

# INDICE - CODICE NUMERICO

CODICE PAGINA	CODICE PAGINA	CODICE PAGINA	CODICE PAGINA	CODICE PAGINA	CODICE PAGINA	CODICE PAGINA
538440 515	546210 520	560185 525	561620 530	563385 533	568320 538	571260 542
538510 516	546240 520	560210 525	561630 530	564180 534	568330 538	571280 542
538511 516	546310 520	560220 525	561640 530	564185 534	568340 538	571420 542
538540 516	546340 520	560230 525	561650 530	564290 534	568370 538	571440 542
538541 516	546410 520	560240 525	561660 530	564295 534	568380 538	571460 542
538550 516	546440 520	560250 525	561670 530	564390 534	568410 539	571480 542
539410 517	548210 521	560310 526	561910 107;531	564395 534	568420 539	571490 542
539411 517	548240 521	560320 526	561920 107;531	565110 535	568430 539	571620 542
539440 517	548440 521	560330 526	561930 107;531	565125 535	568440 539	571640 542
539441 517	549510 521	560370 526	561940 107;531	565135 535	568510 539	571660 543
539710 517	549540 521	560390 526	562210 532	565141 535	568520 539	571680 543
539711 517	560020 522	560550 527	562230 532	565146 535	568530 539	571840 543
539740 517	560025 522	560560 527	562240 532	565151 535	568540 539	571860 543
539741 517	560030 522	560565 527	562250 532	565160 535	568710 540	572530 543
540410 518	560035 522	560570 527	562310 532	565165 535	568720 540	572550 543
540440 518	560060 522	560580 527	562320 532	566160 536	568730 540	572580 543
540510 518	560065 522	560590 527	562330 532	566165 536	568740 540	572740 543
540540 518	560070 522	560610 528	562420 532	566260 536	568810 540	572760 543
540710 518	560120 523	560620 528	562430 532	566265 536	568820 540	572860 543
540740 518	560125 524	560630 528	562440 532	566365 536	568830 540	574560 544
542140 519	560130 523	560640 528	563120 533	566465 536	568840 540	574570 544
542220 519	560135 524	560650 528	563130 533	566470 536	569150 541	574580 544
542240 519	560140 523	560660 528	563160 533	566475 536	569170 541	574590 544
543550 519	560145 524	560810 529	563190 533	567330 537	569310 541	574730 544
543570 519	560150 523	560820 529	563220 533	567360 537	569330 541	574740 544
544110 519	560155 524	560860 529	563230 533	567370 537	569350 541	574750 544
544280 519	560160 523	560870 529	563260 533	567620 537	569440 541	576220 545
544310 519	560165 524	560880 529	563290 533	567625 537	569460 541	576240 545
545280 520	560170 523	560890 529	563360 533	568110 538	569680 541	576260 545
545480 520	560175 524	560895 529	563365 533	568115 538	569940 541	576320 545
545780 520	560180 525	561610 530	563380 533	568310 538	571240 542	576340 545

# INDICE - CODICE NUMERICO

CODICE PAGINA	CODICE PAGINA	CODICE PAGINA	CODICE PAGINA	CODICE PAGINA	CODICE PAGINA	CODICE PAGINA
576360 545	591310 549	625225 603	625830 607	632330 610	647120 615	664140 619
576420 546	591315 549	625230 604	625835 607	632340 611	647130 615	664150 619
576440 546	60 ESTRAZIONE	625235 604	625850 607	632350 611	647135 615	664160 619
576460 546		625250 604	625860 607	632360 611	647210 615	664220 619
576520 546		625260 604	625865 607	632580 611	647230 615	664230 619
576540 546		625270 604	625870 607	632720 611	647250 615	664350 619
581510 547		612210 601	625280 604	625880 607	632740 611	648150 615
581520 547	612220 601	625310 604	625890 607	632750 611	662100 616	664370 619
581530 547	612230 601	625320 604	625910 608	632770 611	662110 616	664380 619
581540 547	612240 601	625410 605	625915 608	644210 612	662120 616	664390 619
581550 547	612250 601	625415 605	625920 608	644220 612	662130 616	664395 619
582510 547	612260 601	625420 605	625930 608	644230 612	662150 616	664510 619
582520 547	612270 601	625450 605	625945 608	644240 612	662160 616	664520 619
582530 547	612275 601	625470 605	625965 608	644250 612	662170 616	664530 620
582540 547	612280 601	625490 605	625980 608	644260 612	662300 617	664540 620
582550 547	612285 601	625510 605	626120 609	644270 612	662310 617	664550 620
582570 547	612410 602	625520 605	626130 609	644320 613	662320 617	664560 620
582580 547	612430 602	625560 605	626140 609	644330 613	662330 617	664570 620
585835 548	612440 602	625565 605	626150 609	644340 613	662340 617	664580 620
585840 548	612450 602	625610 606	626155 609	644350 613	662350 617	664810 620
585845 548	612455 602	625620 606	626160 609	644370 613	662360 617	664820 620
585850 548	612460 602	625630 606	626170 609	644380 613	662600 618	664830 620
585860 548	625110 603	625640 606	632120 610	644390 613	662610 618	664840 620
585870 548	625120 603	625650 606	632140 610	644395 613	662620 618	664850 620
585880 548	625130 603	625660 606	632150 610	644410 614	662630 618	664860 620
591110 549	625140 603	625670 606	632160 610	644420 614	662640 618	666110 621
591150 549	625150 603	625710 606	632165 610	644430 614	662650 618	666120 621
591220 549	625170 603	625730 606	632180 610	644435 614	662660 618	666130 621
591225 549	625180 603	625750 606	632185 610	644440 614	664110 619	666140 621
591240 549	625210 603	625810 607	632310 610	644450 614	664120 619	666150 621
591245 549	625220 603	625815 607	632315 610	647110 615	664130 619	666160 621

# INDICE - CODICE NUMERICO

CODICE PAGINA	CODICE PAGINA	CODICE PAGINA	CODICE PAGINA	CODICE PAGINA	CODICE PAGINA	CODICE PAGINA
666320 621	668180 622	681030 625	713421 703	740630 709	760120 712	813714 802
666325 621	668410 623	681050 625	713521 703	740830 709	760130 712	813724 802
666330 621	668430 623	681110 625	714221 703	744230 709	760140 712	813734 802
666335 621	668440 623	681115 625	714421 703	744330 709	760141 712	813744 802
666340 621	668450 623	681120 625	722220 704	745130 710	762350 714	813754 802
666345 621	668460 623	681130 625	722330 704	745530 710	762420 714	815230 803
666350 621	668470 623	681135 625	722521 704	745730 710	762510 714	815240 803
666355 621	668480 623	681140 625	722720 704	745830 710	762511 714	815250 803
666360 621	668490 623	681145 625	722820 704	746230 710	772220 714	815310 803
666365 621	668610 623	681150 625	731421 705	746330 710	772420 714	815320 803
666370 621	668615 623	681155 625	732120 705	746530 713	772425 714	815330 803
666375 621	668620 623	681160 625	732131 705	746630 713	772433 714	815350 803
666520 622	668625 623	681165 625	732141 705	746721 713	772438 714	815380 803
666525 622	668635 623	682310 625	732160 705	746821 713	772940 715	820110 807
666530 622	668640 623	682320 625	732221 706	746822 713	772945 715	820120 807
666545 622	668645 623	682510 625	732241 706	752120 711	783310 715	820150 807
666550 622	668650 623	682520 625	732430 706	752320 711	783330 715	820160 807
666555 622	668655 623	682530 625	732630 706	752520 711	783340 715	820180 807
666560 622	668660 623	682540 625	732530 707	752720 711	783370 715	822120 808
666565 622	668810 624	70 ORTODONZIA	732730 706	752920 711	783380 715	822130 808
666570 622	668820 624		734730 707	753610 711	80 PROTESICA	822140 808
666710 622	668830 624		734830 707	756515 716		822150 808
666720 622	670610 624		735130 707	756520 716		822160 808
666730 622	670620 624	701020 701	735530 707	756530 716	822170 808	
668110 622	670630 624	711821 701	735630 708	756535 716	813400 801	826590 804
668120 622	671440 624	712021 701	736130 708	756550 716	813410 801	826810 804
668130 622	671450 624	712221 702	736330 708	756555 716	813420 801	826820 804
668140 622	671460 624	712021 702	736530 708	756570 716	813430 801	826830 804
668150 622	671670 624	712221 702	736630 708	756575 716	813440 801	826840 804
668160 622	671680 624	712421 702	740330 709	760110 712	813450 801	826850 804
668170 622	681000 625	712621 702	740430 709	760115 712	813704 802	826860 804

# INDICE - CODICE NUMERICO

CODICE PAGINA	CODICE PAGINA	CODICE PAGINA	CODICE PAGINA	CODICE PAGINA	CODICE PAGINA	CODICE PAGINA
826880 804	841145 809	841390 810	882510 412;812	911630 902	921620 906	923720 908
826890 804	841150 809	845100 811	882650 412;813	911640 902	921625 906	923820 908
828700 805	841155 809	845110 811	882720 812	911650 902	921643 906	923840 908
828720 805	841160 809	845115 811	882730 812	911810 903	921648 906	923860 908
828740 805	841165 809	845120 811	882740 812	911830 903	921820 906	942113 909
828760 805	841170 809	845125 811	882760 812	911840 903	921825 906	942123 909
828800 805	841175 809	845130 811	90 ACCESSORI	911850 903	921843 906	942133 909
828820 805	841180 809	845135 811		913320 904	921848 906	942143 909
828840 805	841190 809	845140 811		913340 904	921920 906	942153 909
828860 805	841300 810	845145 811		915320 904	921925 906	942213 909
831330 806	841310 810	845180 811	911010 901	915340 904	921953 906	942223 909
831340 806	841315 810	845185 811	911030 901	915360 904	921958 906	942233 909
834725 806	841320 810	845190 811	911040 901	915380 904	923220 907	942243 909
835100 806	841325 810	845195 811	911050 901	921220 905	923240 907	942253 909
835200 806	841330 810	845105 811	911210 901	921225 905	923260 907	942323 909
841100 809	841335 810	882110 412;813	911230 901	921243 905	923420 907	942343 909
841110 809	841340 810	882210 412;813	911240 901	921248 905	923425 907	942353 909
841115 809	841345 810	882310 812	911250 901	921420 905	923440 907	
841120 809	841350 810	882320 812	911410 902	921425 905	923445 907	
841125 809	841355 810	882410 412;813	911430 902	921443 905	923520 908	
841130 809	841360 810	882420 412;813	911440 902	921448 905	923540 908	
841135 809	841365 810	882450 812	911450 902	921520 905	923560 908	
841140 809	841380 810	882470 812	911610 902	921523 905	923620 908	



CORICAMA - C17-IT CATALOGO Edizione - Stampato in Luglio 2017

Tutti i diritti riservati. I contenuti di questo Catalogo, inclusi ma non limitati a tutti i testi, i loghi, le immagini e la grafica, sono di sola ed esclusiva proprietà di CORICAMA srl e non possono essere copiati, riprodotti o distribuiti senza previa autorizzazione scritta. CORICAMA srl si riserva il diritto di modificare le caratteristiche di prodotti, immagini e testi in qualsiasi momento senza preavviso. Per i termini e le condizioni generali e garanzia consultare il sito [www.coricama.it](http://www.coricama.it).



**CORICAMA**<sup>®</sup>  
since 1873

**CORICAMA srl**

Via Maniago, 103 - Zona Industriale  
33085 MANIAGO (PN) - ITALIA

Tel.: +39 (0)427 730568

Fax: +39 (0)427 730568

E-mail: [info@coricama.it](mailto:info@coricama.it)

Website: [www.coricama.it](http://www.coricama.it)

VAT No. IT01713980934

REA No. PN98566

Customer care: dal lunedì al venerdì  
dalle 8:30-12:00 alle 14:00-17:00 (GMT +1)



**Distributore:**